

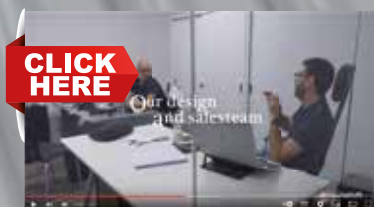

SALVIMAR

Buyer's Guide 2024





I N D E X

SALVIMAR SPEARFISHING

ARBALETE SPEARGUNS	3
POLE SPEAR	28
SPARE PARTS FOR ARBALETE	30
REELS	32
ARBALETE SPEARGUNS ACCESSORIES	33
RUBBERS	34
ARBALETE SPEARGUNS ACCESSORIES / RUBBERS	40
PNEUMATICS	42
PNEUMATICS ACCESSORIES	46
OEM PNEUMATIC SPARE PARTS	50
WETSUITS	51
WETSUITS SIZE CHART	65
GLOVES & SOCKS	68
ACCESSORIES WETSUITS	71
FINS	72
MASKS	83
SNORKELS	90
KNIVES	92
FREEDIVING WATCH	98
TORCHES	101
SPEARFISHING LINES	109
BELTS	113
BAGS	115
WEIGHTS	122
DIVE BOARD	124
BUOYS	125
SHAFTS	128
WISHBONES	140
PRONGS	142
HARPOONS	145
ACCESSORIES	148
SPORTWEAR	153

SALVIMAR WATER SPORTS

WETSUITS	156
RASH GUARD & BUOYS	172

SALVIMAR SNORKELING

MASKS	175
COMBO SET	183
SNORKELS	187
FINS	190
GOGGLES	192
BEACH SHOES	194
DRY BAG BEACH	195



A R B A L E T E





ARES impugnatura NEUTRA - NEUTRAL handgrip



ARES impugnatura NEUTRA con MULINELLO
NEUTRAL handgrip ARES with REEL

- Meccanismo di sgancio R.F.S.C (Rolling, Friction, Self-Centring)
- Sistema di sgancio autocentrante ad attrito volvente
- Asta BOLT con sistema di collimazione della linea di mira (LINE OF SIGHT COLLIMATION)
- Grilletto regolabile Tecnologia M.I.M
- Fusto anodizzato a sezione ellittica con centine esterne di irrigidimento
- Perfetto equilibrio idrostatico con asta da 6,5 mm fornita di serie
- Compatibile con tutti i mulinelli Salvimar
- Compatibile con tutte le aste Salvimar
- Testata con fori separati per elastici 14/16 mm
- Perfetto allineamento asta elastici
- Passaggio sagola maggiorato per agevolare il fissaggio dell'asta
- Guida asta integrale
- Sganciasagola personalizzabile destra sinistra
- Anello fissaggio sotto impugnatura in acciaio inox spessore 4mm
- Lunghezza Asta calcolata per evitare l'O-ring di chiusura aletta
- Mirino posteriore per facilitare il puntamento

- R.F.S.C (Rolling, Friction, Self Centring) release mechanism
- Self-centring release system with rolling friction
- BOLT Shaft with line-of-sight collimation system (LINE OF SIGHT COLLIMATION)
- Adjustable trigger M.I.M Technology
- Anodised barrel with elliptical section and external stiffening ribs
- Perfect hydrostatic balance with 6.5 mm shaft supplied as standard
- Compatible with all Salvimar reels
- Compatible with all Salvimar shafts
- Muzzle with separate holes for 14/16 mm bands
- Perfect shaft-bands alignment.
- Increased sideline passage to facilitate the fixing of the shaft
- Integrated spear guide
- Customizable sideline release right left
- Fixing ring under the stainless-steel handle 4mm thick
- Shaft length calculated to avoid the O-ring for closing the wing
- Rear sight for easy aiming



MINI REEL 50



ARES impugnatura NEUTRA - NEUTRAL handgrip

SIZE	SHAFT Ø	RUBBER Ø	RUBBER LENGHT	COD.	EAN	€
60	BOLT 6,5mm	Eptagum S600 Ø14mm	44 cm	ARB01060	8056138188952	
75	BOLT 6,5mm	Eptagum S600 Ø14mm	48 cm	ARB01075	8056138184992	
85	BOLT 6,5mm	Eptagum S600 Ø14mm	54 cm	ARB01085	8056138185012	
95	BOLT 6,5mm	Eptagum S600 Ø14mm	60 cm	ARB01095	8056138185036	
105	BOLT 6,5mm	Eptagum S600 Ø14mm	64 cm	ARB01105	8056138185050	

ARES impugnatura NEUTRA con MULINELLO - NEUTRAL handgrip with REEL

SIZE	SHAFT Ø	RUBBER Ø	RUBBER LENGHT	REEL	COD.	EAN	€
75	BOLT 6,5mm	Eptagum S600 Ø14mm	48 cm	MINI 50	ARB01075/R	8056138185876	
85	BOLT 6,5mm	Eptagum S600 Ø14mm	54 cm	MINI 50	ARB01085/R	8056138185913	
95	BOLT 6,5mm	Eptagum S600 Ø14mm	60 cm	MINI 50	ARB01095/R	8056138185920	
105	BOLT 6,5mm	Eptagum S600 Ø14mm	64 cm	MINI 50	ARB01105/R	8056138185937	



MADE IN ITALY

NEW ARRIVAL

ARES impugnatura DESTRA - RIGHT handgrip



ARES impugnatura DESTRA con MULINELLO
RIGHT handgrip ARES with REEL



CLICK HERE

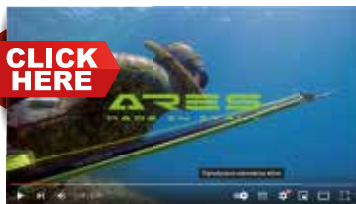

CLICK HERE



MINI REEL 50

ARES impugnatura DESTRA - RIGHT handgrip

SIZE	SHAFT Ø	RUBBER Ø	RUBBER LENGHT	COD.	EAN	€
60	BOLT 6,5mm	Eptagum S600 Ø14mm	44 cm	ARB02060	8056138188969	
75	BOLT 6,5mm	Eptagum S600 Ø14mm	48 cm	ARB02075	8056138185005	
85	BOLT 6,5mm	Eptagum S600 Ø14mm	54 cm	ARB02085	8056138185029	
95	BOLT 6,5mm	Eptagum S600 Ø14mm	60 cm	ARB02095	8056138185043	
105	BOLT 6,5mm	Eptagum S600 Ø14mm	64 cm	ARB02105	8056138185067	

ARES impugnatura DESTRA con MULINELLO - RIGHT hand grip with REEL

SIZE	SHAFT Ø	RUBBER Ø	RUBBER LENGHT	REEL	COD.	EAN	€
75	BOLT 6,5mm	Eptagum S600 Ø14mm	48 cm	MINI 50	ARB02075/R	8056138185944	
85	BOLT 6,5mm	Eptagum S600 Ø14mm	54 cm	MINI 50	ARB02085/R	8056138185951	
95	BOLT 6,5mm	Eptagum S600 Ø14mm	60 cm	MINI 50	ARB02095/R	8056138185968	
105	BOLT 6,5mm	Eptagum S600 Ø14mm	64 cm	MINI 50	ARB02105/R	8056138185975	



MADE IN ITALY

NEW ARRIVAL

ARES NIGHTMARE impugnatura NEUTRA - NEUTRAL handgrip



Salvimar by Primeline, elastico in lattice naturale di elevata qualità prodotto dalla **Primeline Industries U.S.A.**, offre altissime prestazioni.

Salvimar by Primeline, natural latex rubber band of the highest quality produced by **Primeline Industries U.S.A.**, offers very high performance.

- Meccanismo di sgancio R.F.S.C (Rolling, Friction, Self-Centring)
- Sistema di sgancio autocentrante ad attrito volvente
- Asta BOLT con sistema di collimazione della linea di mira (LINE OF SIGHT COLLIMATION)
- Grilletto regolabile Tecnologia M.I.M
- Fusto anodizzato a sezione ellittica con centine esterne di irrigidimento
- **Perfetto equilibrio idrostatico con asta da 7,0 mm fornita di serie**
- Compatibile con tutti i mulinelli Salvimar
- Compatibile con tutte le aste Salvimar
- Testata con fori separati per elastici 14/16 mm
- Perfetto allineamento asta elastici
- Passaggio sagola maggiorato per agevolare il fissaggio dell'asta
- Guida asta integrale
- Sganciasagola personalizzabile destra sinistra
- Anello fissaggio sotto impugnatura in acciaio inox spessore 4mm
- Lunghezza Asta calcolata per evitare l'O-ring di chiusura aletta
- Mirino posteriore per facilitare il puntamento

- R.F.S.C (Rolling, Friction, Self Centring) release mechanism
- Self-centring release system with rolling friction
- BOLT Shaft with line-of-sight collimation system (LINE OF SIGHT COLLIMATION)
- Adjustable trigger M.I.M Technology
- Anodised barrel with elliptical section and external stiffening ribs
- **Perfect hydrostatic balance with 7,0 mm shaft supplied as standard**
- Compatible with all Salvimar reels
- Compatible with all Salvimar shafts
- Muzzle with separate holes for 14/16 mm bands
- Perfect shaft-bands alignment.
- Increased sideline passage to facilitate the fixing of the shaft
- Integrated spear guide
- Customizable sideline release right left
- Fixing ring under the stainless-steel handle 4mm thick
- Shaft length calculated to avoid the O-ring for closing the wing
- Rear sight for easy aiming

ARES impugnatura NEUTRA - NEUTRAL handgrip

SIZE	SHAFT Ø	RUBBER Ø	RUBBER LENGHT	COD.	EAN	€
75	BOLT 7,0mm	Primeline Ø14mm	48 cm	ARB04075	8056138186293	
85	BOLT 7,0mm	Primeline Ø14mm	54 cm	ARB04085	8056138186309	
95	BOLT 7,0mm	Primeline Ø14mm	60 cm	ARB04095	8056138186316	
105	BOLT 7,0mm	Primeline Ø14mm	64 cm	ARB04105	8056138186323	



MADE IN ITALY

NEW ARRIVAL

ARES NIGHTMARE impugnatura DESTRA - RIGHT handgrip



Salvimar by Primeline, elastico in lattice naturale di elevata qualità prodotto dalla *Primeline Industries U.S.A.*, offre altissime prestazioni.

Salvimar by Primeline, natural latex rubber band of the highest quality produced by *Primeline Industries U.S.A.*, offers very high performance.



MADE IN ITALY

ARES NIGHTMARE

ARES impugnatura DESTRA - RIGHT handgrip

SIZE	SHAFT Ø	RUBBER Ø	RUBBER LENGHT	COD.	EAN	€
75	BOLT 7,0mm	Primeline Ø14mm	48 cm	ARB05075	8056138186330	
85	BOLT 7,0mm	Primeline Ø14mm	54 cm	ARB05085	8056138186347	
95	BOLT 7,0mm	Primeline Ø14mm	60 cm	ARB05095	8056138186354	
105	BOLT 7,0mm	Primeline Ø14mm	64 cm	ARB05105	8056138186361	



MADE IN ITALY

HERO



PONTICELLO TESTATA 65/75/85/95cm
MUZZLES BRIDGE 65/75/85/95cm



MECCANISMO DI SGANCIO HERO
HERO TRIGGER MECHANISM

- Fusto ellittico asimmetrico in lega di alluminio aeronautico
- Sistema di sgancio Heavy Metal 350
- Impugnatura con calcio destro e sinistro di serie
- Guidasta in Teflon*
- Profilo maggiorato per un migliore assetto idrostatico
- Regolazione del grilletto sensitive
- Appoggio sternale in gomma morbida
- Impugnatura con gancio fissaggio sagola o moschettone rinforzato
- Testata aperta multielastico
- Mulinello di serie

- Aircraft grade aluminium alloy elliptical barrel
- HEAVY METAL 350 trigger mechanism
- Handle with left and right butt
- Teflon* Shaft guide
- Enlarged profile for a better hydrostatic trim
- Trigger sensitivity adjustment
- Chest loading pad of soft rubber
- Handle with hook for line fixing or reinforced snap hook
- Open multi band muzzle
- Stock reel



MINI REEL 50



MAX REEL



SIZE	SHAFT Ø	RUBBER Ø	RUBBER LENGHT	REEL	COD.	EAN	€
65cm	7,0mm	Pair 16,00mm	44cm	MINI 50	300300/065	8058093685019	
75cm	7,0mm	Pair 16,00mm	48cm	MINI 50	300300/075	8058093681776	
85cm	7,0mm	Pair 16,00mm	54cm	MINI 50	300300/085	8058093681783	
95cm	7,0mm	Pair 16,00mm	60cm	MAX	300300/095	8058093681790	
105cm	7,5mm	Pair 16,00mm	64cm	MAX	300300/105	8058093681950	
115cm	7,5mm	Pair 16,00mm	70cm	MAX	300300/115	8058093681967	
125cm	7,5mm	Triple rubber 14,00mm	75cm	MAX	300300/125	8058093681974	
135cm	7,5mm	Triple rubber 14,00mm	80cm	MAX	300300/135	8058093681981	





MADE IN ITALY

NEW ARRIVAL

HERO NIGHTMARE

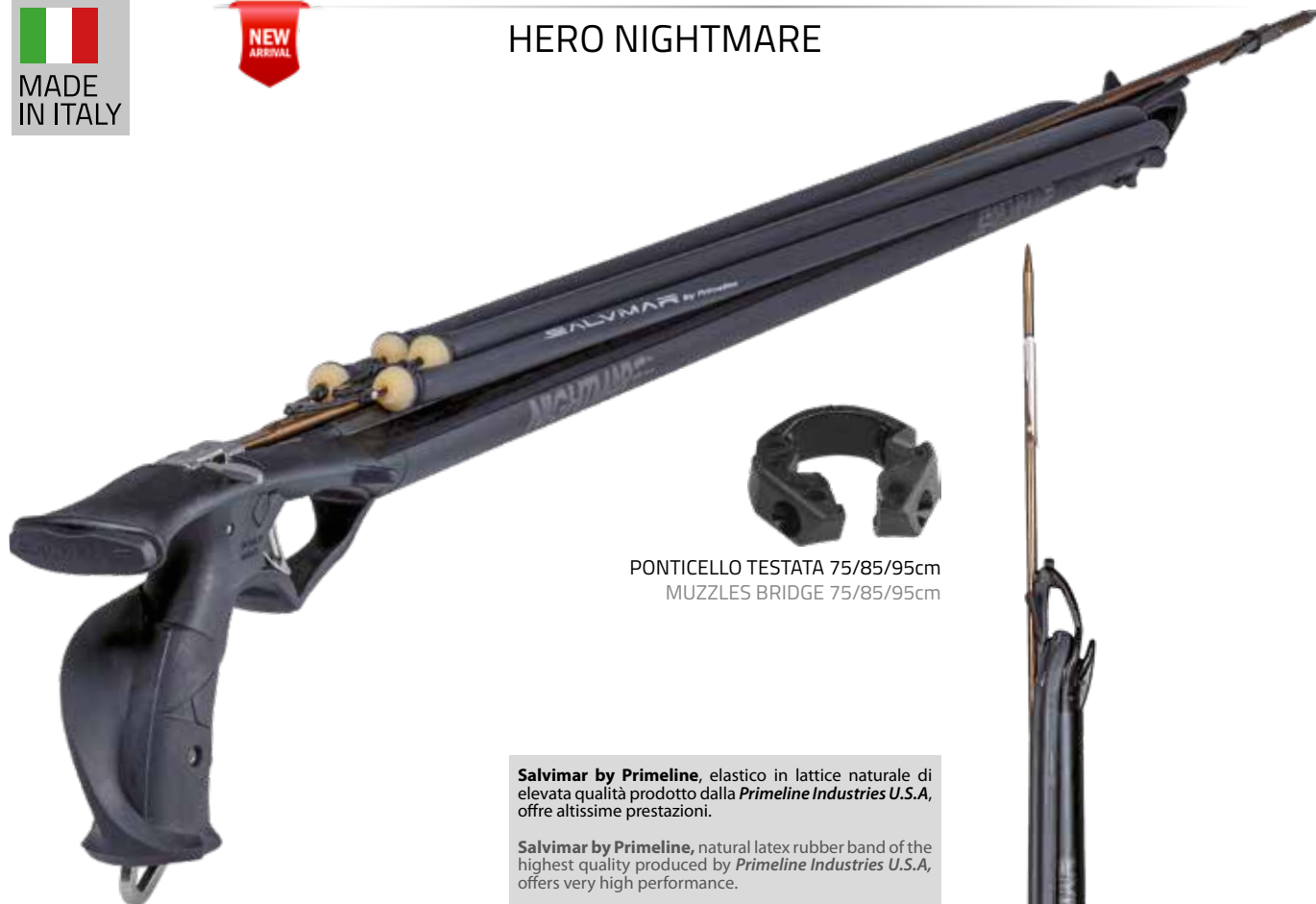

PONTICELLO TESTATA 75/85/95cm
MUZZLES BRIDGE 75/85/95cm

Salvimar by Primeline, elastico in lattice naturale di elevata qualità prodotto dalla **Primeline Industries U.S.A.**, offre altissime prestazioni.

Salvimar by Primeline, natural latex rubber band of the highest quality produced by **Primeline Industries U.S.A.**, offers very high performance.

- Fusto ellittico asimmetrico in lega di alluminio aeronautico
- Sistema di sgancio Heavy Metal 350
- Impugnatura con calcio destro e sinistro di serie
- Guidasta in Teflon*
- Profilo maggiorato per un migliore assetto idrostatico
- Regolazione del grilletto sensitive
- Appoggio sternale in gomma morbida
- Impugnatura con gancio fissaggio sagola o moschettone rinforzato
- Testata aperta multielastico
- Elastici legati con ogiva in dyneema Primeline Ø16mm
- Predisposizione per mulinelli Salvimar

- Aircraft grade aluminium alloy elliptical barrel
- HEAVY METAL 350 trigger mechanism
- Handle with left and right butt
- Teflon* Shaft guide
- Enlarged profile for a better hydrostatic trim
- Trigger sensitivity adjustment
- Chest loading pad of soft rubber
- Handle with hook for line fixing or reinforced snap hook
- Open multi band muzzle
- Primeline rubbers Ø16mm with Dyneema soft wishbones
- Predisposition for Salvimar reels



RUBBERS SALVIMAR by Primeline

SIZE	SHAFT Ø	RUBBER Ø	RUBBER LENGHT	COD.	EAN	€
75	7,0mm	Pair 16,00mm Prime	48cm	ARB03075	8056138185708	
85	7,0mm	Pair 16,00mm Prime	54cm	ARB03085	8056138185715	
95	7,0mm	Pair 16,00mm Prime	60cm	ARB03095	8056138185722	
105	7,5mm	Pair 16,00mm Prime	64cm	ARB03105	8056138185739	
115	7,5mm	Pair 16,00mm Prime	70cm	ARB03115	8056138185746	
125	7,5mm	Pair 16,00mm Prime	75cm	ARB03125	8056138185753	





MADE IN ITALY

HERO STORM

PONTICELLO TESTATA 85/95cm
MUZZLES BRIDGE 85/95cm

- Fusto ellittico asimmetrico in lega di alluminio aeronautico
- Mimetizzato in sublimazione permanent
- Appoggio sternale in gomma morbida
- Guidasta in Teflon*
- Profilo maggiorato per un migliore assetto idrostatico
- Impugnatura ergonomica con calcio destro e sinistro di serie
- Nuovo meccanismo di sgancio Heavy Metal 350 (Carico testato 350kg)
- Regolazione del grilletto sensitive
- Impugnatura con gancio fissaggio sagola o moschettone rinforzato
- Testata aperta multielastico
- Mulinello di serie

- Aircraft grade aluminium alloy elliptical barrel
- Camouflaged using permanent sublimation technology
- Chest loading pad of soft rubber
- Teflon* Shaft guide
- Enlarged profile for a better hydrostatic trim
- Ergonomic handle with left and right butt
- New Heavy Metal 350 trigger mechanism (Muzzle tested 350kg)
- Trigger sensitivity adjustment
- Handle with hook for line fixing or reinforced snap hook
- Open multi band muzzle
- Reel as standard



VERTICAL REEL 70



SIZE	SHAFT Ø	RUBBER Ø	RUBBER LENGHT	REEL	COD.	EAN	€
85cm	7,0mm	Pair 16,00mm	54cm	VERTICAL 70	300300/085GH	8058093685941	
95cm	7,0mm	Pair 16,00mm	60cm	VERTICAL 70	300300/095GH	8058093683893	
105cm	7,5mm	Pair 16,00mm	64cm	VERTICAL 70	300300/105GH	8058093685958	
115cm	7,5mm	Pair 16,00mm	70cm	VERTICAL 70	300300/115GH	8058093683909	



MADE IN ITALY

HERO KRYPSIS



PONTICELLO TESTATA 75/85/95cm
MUZZLES BRIDGE 75/85/95cm

- Impugnatura, fusto e testata mimetizzati in sublimazione permanente
- Sistema di sgancio Heavy Metal 350
- Impugnatura con calcio destro e sinistro di serie
- Fusto ellittico asimmetrico in lega di alluminio aeronautico
- Guidasta in Teflon®
- Profilo maggiorato per un migliore assetto idrostatico
- Regolazione del grilletto sensitive
- Appoggio sternale in gomma morbida
- Impugnatura con gancio fissaggio sagola o moschettone rinforzato
- Testata aperta multielastico
- Predisposizione mulinelli Salvimar

- Handle, barrel and muzzle camouflaged in permanent sublimation
- HEAVY METAL 350 trigger mechanism
- Handle with left and right butt
- Aircraft grade aluminium alloy elliptical barrel
- Teflon® Shaft guide
- Enlarged profile for a better hydrostatic trim
- Trigger sensitivity adjustment
- Chest loading pad of soft rubber
- Handle with hook for line fixing or reinforced snap hook
- Open multi band muzzle
- Fitting for Salvimar reels



SIZE	SHAFT Ø	RUBBER Ø	RUBBER LENGHT	COD.	EAN	€
75cm	7,0mm	Pair 16,00mm	48cm	300300K075	8056138182486	
85cm	7,0mm	Pair 16,00mm	54cm	300300K085	8056138182479	
95cm	7,0mm	Pair 16,00mm	60cm	300300K095	8056138182493	
105cm	7,5mm	Pair 16,00mm	64cm	300300K105	8056138182509	

MADE
IN ITALY

HERO ROLLER



- Fusto ellittico asimmetrico in lega di alluminio aeronautico
- Testata ROLLER HERO
- Guidasta in Teflon*
- Profilo maggiorato per un migliore assetto idrostatico
- Regolazione del grilletto sensitive
- Appoggio sternale in gomma morbida
- Impugnatura con gancio fissaggio sagola o moschettone rinforzato
- Nuovo meccanismo di sgancio Heavy Metal 350 (Carico testato 350kg)
- Impugnatura ergonomica con calcio destro e sinistro di serie
- Predisposizione per mulinelli Salvimar
- Aircraft grade aluminium alloy elliptical barrel
- HERO ROLLER muzzle
- Teflon* Shaft guide
- Enlarged profile for a better hydrostatic trim
- Trigger sensitivity adjustment
- Chest loading pad of soft rubber
- Handle with hook for line fixing or reinforced snap hook
- New Heavy Metal 350 trigger mechanism (Muzzle tested 350kg)
- Ergonomic handle with left and right butt
- Fitting for SALVIMAR reels

BAND FOR LOADING SUPPORT
INCLUDED

SIZE	SHAFT Ø	RUBBER Ø	LENGHT	COD.	EAN	€
65cm	7,0mm	Pair 16,00mm	44cm	300300R065	8058093686504	
75cm	7,0mm	Pair 16,00mm	48cm	300300R075	8058093686511	
85cm	7,0mm	Pair 16,00mm	54cm	300300R085	8058093686528	
95cm	7,0mm	Pair 16,00mm	60cm	300300R095	8058093686535	
105cm	7,5mm	Pair 16,00mm	64cm	300300R105	8058093686542	
115cm	7,5mm	Pair 16,00mm	70cm	300300R115	8058093686559	
125cm	7,5mm	Pair 16,00mm	75cm	300300R125	8058093686566	
135cm	7,5mm	Pair 16,00mm	80cm	300300R135	8058093686573	



MADE IN ITALY

HERO TOMAHAWK



CLICK HERE



- Fusto ellittico asimmetrico, lega di alluminio aeronautico
- Guidasta in Teflon*
- Profilo maggiorato per un migliore assetto idrostatico
- Regolazione del grilletto sensitive
- Appoggio sternale in gomma morbida
- Impugnatura con gancio fissaggio sagola o moschettone rinforzato
- Nuovo meccanismo di sgancio Heavy Metal 350 (Carico testato 350kg)
- Impugnatura ergonomica con calcio destro e sinistro di serie
- Predisposizione per mulinelli Salvimar
- Sistema di propulsione Tomahawk costituito da: Elastici superiori S400 ad allungamento controllato mediante anima interna in sagola Dymax, 100% Climax® da 1,4mm, 250kg di carico di rottura + n° 4 elastici supplementari in linea S400R ø 15mm

- Aircraft grade aluminium alloy elliptical barrel
- Teflon® shaft guide
- Enlarged profile for a hydrostatic trim
- Trigger sensitive adjustment
- Chest loading pad of soft rubber
- Handle with hook for line fixing or reinforced snap hook
- New Heavy Metal 350 release mechanism (Tested load 350kg)
- Ergonomic handle with left and right butt
- Fitting for Salvimar reels
- Tomahawk propulsion system consisting of: Upper rubbers S400 ø 16mm with elongation controlled by inner core in Dymax line, 100% Climax® 1.4mm, tensile strength 250kg + 4 additional S400R rubbers in line ø 15mm

Rispetto a un ROLLER standard il sistema Tomahawk sviluppa una potenza del 35% superiore grazie alla spinta fornita dai 4 elastici supplementari il cui allungamento comincia quando l'elastico superiore ha raggiunto l'estensione ideale vincolata dall'anima interna

Compared to a standard ROLLER the Tomahawk system develops 35% more power thanks to the thrust provided by the 4 additional rubbers whose elongation starts when the upper rubber has reached the ideal extension constrained by the inner core

SIZE	SHAFT Ø	RUBBER	LENGHT	COD.	EAN	€
65cm	7,0mm	KIT elastici Tomahawk	2 black Ø16mmx22cm + 4 red Ø15mmx18cm	300300T065	8058093688782	
75cm	7,0mm	KIT elastici Tomahawk	2 black Ø16mmx24cm + 4 red Ø15mmx20cm	300300T075	8058093687587	
85cm	7,0mm	KIT elastici Tomahawk	2 black Ø16mmx27cm + 4 red Ø15mmx23cm	300300T085	8058093687754	
95cm	7,5mm	KIT elastici Tomahawk	2 black Ø16mmx30cm + 4 red Ø15mmx26cm	300300T095	8058093687594	
105cm	7,5mm	KIT elastici Tomahawk	2 black Ø16mmx33cm + 4 red Ø15mmx28cm	300300T105	8058093687747	
115cm	7,5mm	KIT elastici Tomahawk	2 black Ø16mmx35cm + 4 red Ø15mmx31cm	300300T115	8058093687600	
125cm	7,5mm	KIT elastici Tomahawk	2 black Ø16mmx38cm + 4 red Ø15mmx34cm	300300T125	8058093687839	
135cm	7,5mm	KIT elastici Tomahawk	2 black Ø16mmx41cm + 4 red Ø15mmx37cm	300300T135	8058093688799	

MADE
IN ITALY

METAL



- Fusto in lega di alluminio aeronautico con guida asta integrale
- Profilo frazionato per un miglior brandeggio
- Impugnatura con sistema di sgancio METAL
- Regolazione del grilletto Sensitive
- Appoggio sternale facilmente estraibile
- Testata Enclosed Track rinforzata, aperta multi elastico
- Elastici legati di serie con ogiva in Dyneema 14 mm
- Asta con pinnette a saldatura laser
- Mulinello di serie

- Aircraft grade aluminum barrel with integrated shaft guide
- Tapered fractioned profile for improved maneuverability
- Handle with METAL trigger mechanism
- Trigger sensitivity adjustment
- Removable chest loading butt pad
- Enclosed track muzzle, open multiband muzzle
- 14 mm Dyneema soft wishbones
- Shaft with Laser welded shark fin tabs
- Stock reel



MINI REEL 50



MAX REEL



SIZE	SHAFT Ø	RUBBER Ø	RUBBER LENGTH	REEL	COD.	EAN	€
60cm	6,5mm	Pair 14,00mm	44cm	MINI 50	300060MET	8058093688829	
75cm	6,5mm	Pair 14,00mm	48cm	MINI 50	300075MET	8057685559431	
85cm	6,5mm	Pair 14,00mm	54cm	MINI 50	300085MET	8057685559448	
95cm	6,5mm	Pair 14,00mm	60cm	MINI 50	300095MET	8057685559455	
105cm	6,5mm	Pair 14,00mm	64cm	MAX	300105MET	8057685559462	
115cm	7,0mm	Pair 14,00mm	70cm	MAX	300115MET	8057685559479	
125cm	7,0mm	Pair 14,00mm	75cm	MAX	300125MET	8057685559486	





MADE IN ITALY

METAL MONO



- Fusto in lega di alluminio aeronautico con guida asta integrale
- Profilo frazionato per un miglior brandeggio
- Impugnatura con sistema di sgancio METAL
- Regolazione del grilletto Sensitive
- Appoggio sternale facilmente estraibile
- Testata Enclosed Track rinforzata, aperta multi elastico
- Elastico legato di serie con ogiva in Dyneema 16 mm
- Asta con pinnette a saldatura laser

- Aircraft grade alluminum barrel with integrated shaft guide
- Tapered fractioned profile for improved maneuverability
- Handle with METAL trigger mechanism
- Trigger sensitivity adjustment
- Removable chest loading butt pad
- Enclosed track muzzle, open multiband muzzle
- 16 mm Dyneema soft wishbones
- Shaft with Laser welded shark fin tabs



SIZE	SHAFT Ø	RUBBER Ø	RUBBER LENGHT	COD.	EAN	€
60cm	6.25mm	16,00mm	44cm	ARB20060	8056138182059	
75cm	6.25mm	16,00mm	48cm	ARB20075	8056138182066	
85cm	6.25mm	16,00mm	54cm	ARB20085	8056138182073	



MADE
IN ITALY

METAL CARBO OPEN



- Fusto in carbonio diametro esterno 28mm
- Testata aperta multi elastico
- Impugnatura con sistema di sgancio METAL
- Regolazione del grilletto Sensitive
- Elastici legati di serie con ogiva in Dyneema
- Asta capture da 6,5 mm
- Appoggio sternale facilmente estraibile
- Predisposizione per mulinello Salvimar

- Carbon barrel with outer diameter 28mm
- Open muzzle multi band
- Handle with METAL trigger mechanism
- Trigger sensitivity adjustment
- Dyneema soft wishbones
- 6,5 mm Capture shaft
- Removable butt pad
- Reel mounted included



SIZE	SHAFT Ø	RUBBER Ø	RUBBER LENGHT	COD.	EAN	€
95cm	6,5mm	16,00mm	60cm	300MCO095	8056138184121	
105cm	7,0mm	16,00mm	70cm	300MCO105	8056138184138	
115cm	7,0mm	16,00mm	75cm	300MCO115	8056138184145	



MADE IN ITALY

METAL KRYPISIS



- Fusto in lega di alluminio aeronautico con guida asta integrale
- Mimetizzato in sublimazione permanente
- Mimetismo Krypsis Salvimar Pattern
- Impugnatura con sistema di sgancio METAL
- Regolazione del grilletto Sensitive
- Appoggio sternale facilmente estraibile
- Testata Enclosed Track rinforzata, aperta multi elastico
- Elastici legati di serie EPTAGUM con ogiva in Dyneema
- Asta con pinnette a saldatura laser Folgore
- Predisposizione per mulinello

- Aircraft grade aluminum barrel with integrated shaft guide
- Camouflaged using permanent sublimation technology
- Salvimar Krypsis Camouflage Pattern
- Handle with METAL trigger mechanism
- Trigger sensitivity adjustment
- Removable chest loading butt pad
- Enclosed track muzzle, open multiband muzzle
- EPTAGUM series Dyneema soft wishbones
- Folgore Shaft with Laser welded shark fin tabs
- Fitting for reel



SIZE	SHAFT Ø	RUBBER Ø	RUBBER LENGHT	COD.	EAN	€
60cm	6,5mm	Pair 145	44 cm	300060MK	8058093688812	
75cm	6,5mm	Pair 145	48cm	300075MK	8058093687679	
85cm	6,5mm	Pair 145	54cm	300085MK	8058093687686	
95cm	6,5mm	Pair 145	60cm	300095MK	8058093687693	
105cm	6,5mm	Pair 145	64cm	300105MK	8058093687709	
115cm	7,0mm	Pair 145	70cm	300115MK	8058093687716	



MADE
IN ITALY

METAL ROLLER



- Fusto in lega di alluminio aeronautico con guida asta integrale
- Impugnatura con sistema di sgancio METAL
- Elastico facilitatore
- Appoggio sternale facilmente estraibile
- Regolazione del grilletto Sensitive
- Testata roller (cod. 303000)
- Asta Capture
- Predisposizione per mulinelli Salvimar

- Aircraft grade aluminium alloy barrel with continuous rail
- Handle with METAL trigger mechanism
- Band loading support
- Removable chest loading butt pad
- Trigger sensitivity adjustment
- Roller muzzle (cod. 303000)
- Capture shaft
- Dovetail fitting for reels option



BAND FOR LOADING SUPPORT - INCLUDED

COD.	EAN	€
303010	8058093682278	

SIZE	SHAFT Ø	RUBBER Ø	RUBBER LENGHT	COD.	EAN	€
60cm	6,5mm	Pair 16,00mm	44cm	3000R060	8058093681578	
75cm	6,5mm	Pair 16,00mm	48cm	3000R075	8058093680946	
85cm	6,5mm	Pair 16,00mm	54cm	3000R085	8058093680953	
95cm	6,5mm	Pair 16,00mm	60cm	3000R095	8058093680960	
105cm	6,5mm	Pair 16,00mm	64cm	3000R105	8058093680977	
115cm	6,5mm	Pair 16,00mm	70cm	3000R115	8058093680984	
125cm	6,5mm	Pair 16,00mm	75cm	3000R125	8058093681042	





MADE IN ITALY

METAL CARBO ROLLER



- Fusto 100% in carbonio diametro esterno 28mm
- Testata Roller
- Impugnatura con sistema di sgancio METAL
- Regolazione del grilletto Sensitive
- Elastico S400
- Asta capture da 7mm
- Appoggio sternale facilmente estraibile
- Predisposizione per mulinello Salvimar

- 100% Carbon barrel with outer diameter 28mm
- Muzzle Roller
- Open muzzle multi band
- Handle with METAL trigger mechanism
- Bands S400
- 7mm Capture shaft
- Removable butt pad
- Reel mounted included



ROLLER MUZZLE

COD.	EAN	€
303000	8058093680632	

SIZE	SHAFT Ø	RUBBER Ø	RUBBER LENGHT	COD.	EAN	€
60cm	7,0mm	Pair 16,00mm	44cm	300MCR060	8056138184152	
75cm	7,0mm	Pair 16,00mm	48cm	300MCR075	8056138184169	
85cm	7,0mm	Pair 16,00mm	54cm	300MCR085	8056138184176	
95cm	7,0mm	Pair 16,00mm	60cm	300MCR095	8056138184183	
105cm	7,0mm	Pair 16,00mm	70cm	300MCR105	8056138184190	
115cm	7,0mm	Pair 16,00mm	75cm	300MCR115	8056138184206	



MADE
IN ITALY

TESTATA ROLLER

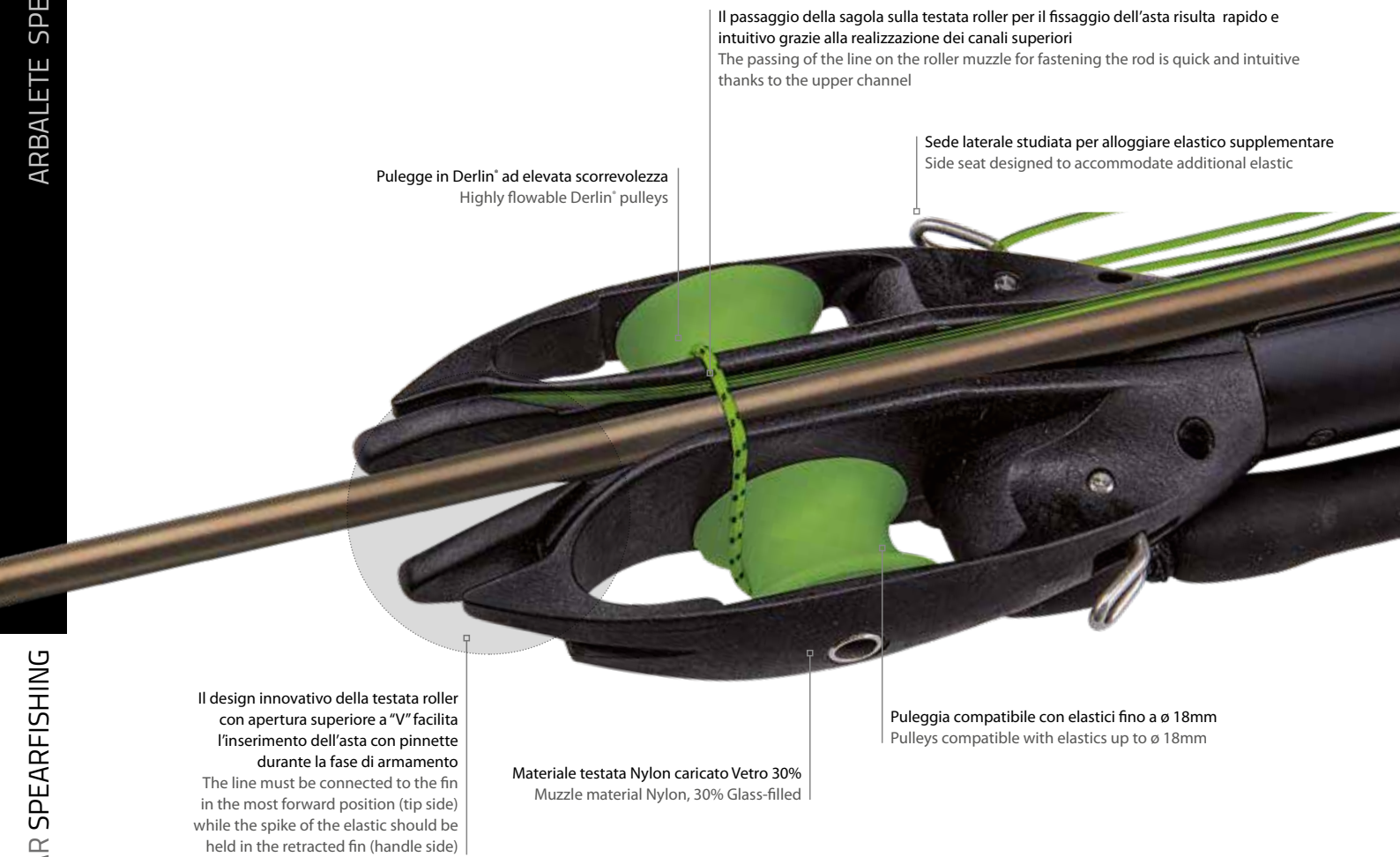

Il passaggio della sagola sulla testata roller per il fissaggio dell'asta risulta rapido e intuitivo grazie alla realizzazione dei canali superiori
The passing of the line on the roller muzzle for fastening the rod is quick and intuitive thanks to the upper channel

Pulegge in Derlin® ad elevata scorrevolezza
Highly flowable Derlin® pulleys

Sede laterale studiata per alloggiare elastico supplementare
Side seat designed to accommodate additional elastic

Il design innovativo della testata roller con apertura superiore a "V" facilita l'inserimento dell'asta con pinnette durante la fase di armamento
The line must be connected to the fin in the most forward position (tip side) while the spike of the elastic should be held in the retracted fin (handle side)

Materiale testata Nylon caricato Vetro 30%
Muzzle material Nylon, 30% Glass-filled

Puleggia compatibile con elastici fino a ø 18mm
Pulleys compatible with elastics up to ø 18mm

- Peso del raccordo testata /fusto ø26mm, 34gr
- Si consiglia di utilizzare aste con pinnette con foro Capture
- La sagola deve essere collegata alla pinnetta più avanzata (lato punta) mentre l'ogiva dell'elastico deve essere incoccata nella pinnetta più arretrata (lato impugnatura)
- Utilizzare elastici ufficiali Salvimar che non contengono all'interno sfere per legatura

- Weight of muzzle/body connection ø26mm, 34gr
- It is recommended to use rods with fins with Capture laser hol
- The line must be connected to the fin in the most forward position (tip side) while the spike of the elastic should be held in the retracted fin (handle side)
- Use official Salvimar "FORMULA R" wishbones that do not contain balls for binding



ROLLER MUZZLE

WEIGHT	MODEL	COD.	EAN	€
109 gr.	Salvimar Aluminum/Wild Carbo	303000	8058093680632	
109 gr.	Salvimar Sapiens	303000/25	8058093681585	

ADAPTERS

Ø	COD.	EAN	€
24,8mm	301024	8058093682889	
25,5mm	301025/5	8058093682896	
25,6mm with double oring	301025/6	8058093684197	
26,5mm	301026/5	8058093683596	







MADE IN ITALY

V-PRO



- Impugnatura con sistema di sgancio VOODOO
- Fusto in lega di alluminio aeronautico con guida asta integrale
- Testata aperta multi elastico
- Regolazione del grilletto Sensitive
- Appoggio sternale facilmente estraibile
- Elastici legati di serie con ogiva in Dyneema Acid Green
- Asta con pinnette a saldatura laser, 14 mm
- Mulinello di serie

- Handle with VOODOO trigger mechanism
- Aircraft grade Aluminum barrel with integrated shaft guide
- Open muzzle multi band
- Trigger sensitivity adjustment screw
- Removable butt pad
- Acid Green Dyneema soft wishbones
- Laser welded 14 mm shark-fin tabs with a cheater fin for easy loading
- Stock reel



MINI REEL 50



MAX REEL



SIZE	SHAFT Ø	RUBBER Ø	RUBBER LENGHT	REEL	COD.	EAN	€
60cm	6,5mm	Pair 14,00mm Acid Green	44cm	MINI 50	300060ROP	8058093688836	
75cm	6,5mm	Pair 14,00mm Acid Green	48cm	MINI 50	300075ROP	8055960722594	
85cm	6,5mm	Pair 14,00mm Acid Green	54cm	MINI 50	300085ROP	8055960722600	
95cm	6,5mm	Pair 14,00mm Acid Green	60 cm	MINI 50	300095ROP	8055960722617	
105cm	6,5mm	Pair 14,00mm Acid Green	64 cm	MAX	300105ROP	8055960722624	



MADE
IN ITALY

VOODOO



- Impugnatura con sistema di sgancio VODOO
- Fusto cilindrico ø 28mm in lega di alluminio aeronautico
- Regolazione del grilletto Sensitive
- Appoggio sternale facilmente estraibile
- Testata a ponticello
- Elastici con boccola filettata
- Asta Tahitiana
- Predisposizione per mulinelli Salvimar

- Handle with VODOO trigger mechanism
- Round 28mm, (1 1/8") aircraft grade aluminum barrel
- Trigger sensitivity adjustment screw
- Removable butt pad
- Screw in bands for simple single band loading
- Notched Tahitian shaft
- Reel mount included

SIZE	SHAFT Ø	RUBBER Ø	RUBBER LENGTH	COD.	EAN	€
60cm	6,5mm	Pair 16,00mm	18 cm	300060/VO	8055960722488	
75cm	6,5mm	Pair 16,00mm	20 cm	300075/VO	8055960722495	
85cm	6,5mm	Pair 16,00mm	24 cm	300085/VO	8055960722501	
95cm	6,5mm	Pair 16,00mm	26 cm	300095/VO	8055960722518	
105cm	6,5mm	Pair 16,00mm	28 cm	300105/VO	8055960722525	

MADE
IN ITALY

MONO RAIL



- Impugnatura con sistema di sgancio WILD
- Fusto in lega di alluminio aeronautico con guida asta integrale
- Regolazione del grilletto Sensitive
- Appoggio sternale facilmente estraibile
- Elastico legato di serie con ogiva in Dyneema 16mm
- Testata aperta multi elastico
- Asta con pinnette a saldatura laser

- Handle with WILD trigger mechanism
- Aircraft grade Aluminum barrel with integrated shaft guide
- Trigger sensitivity adjustment screw
- Removable butt pad
- Dyneema soft wishbones 16mm
- Open muzzle multi band
- Laser welded shark-fin tabs with a cheater fin for easy loading



SIZE	SHAFT Ø	RUBBER Ø	RUBBER LENGTH	COD.	EAN	€
60cm	6,25mm	16,00mm	44cm	ARB40060	8056138182080	
75cm	6,25mm	16,00mm	48cm	ARB40075	8056138182097	
85cm	6,25mm	16,00mm	54cm	ARB40085	8056138182103	





MADE IN ITALY

WILD PRO - WILD



WILD PRO

- Impugnatura con sistema di sgancio WILD
- Fusto cilindrico ø 28mm in lega di alluminio aeronautico
- Testata a ponticello
- Elastici con boccola filettata
- Asta Tahitiana
- Predisposizione per mulinello Salvimar
- Handle with WILD trigger mechanism
- Round 28mm, (1 1/8") aircraft grade aluminum barrel
- Screw in bands for simple single band loading
- Notched Tahitian shaft

WILD

- Impugnatura con sistema di sgancio WILD
- Fusto cilindrico ø 28mm in lega di alluminio aeronautico
- Mono elastico
- Elastico circolare con ogive in plastica
- Arbalete facile da caricare
- Asta filettata con fiocina 3 punte di serie
- Predisposizione per mulinello Salvimar
- Handle with WILD trigger mechanism
- Round 28mm (1 1/8") aircraft grade aluminum barrel
- Single band
- Screwed bands
- Simple loading
- Threaded shaft with 3 points prong



WILD PRO

SIZE	SHAFT Ø	RUBBER Ø	RUBBER LENGHT	COD.	EAN	€
40cm	6,5mm	Pair 14,00mm	12cm	300WP40	8058093683824	
50cm	6,5mm	Pair 14,00mm	14cm	300WP50	8058093683862	
60cm	6,5mm	Pair 14,00mm	16cm	300WP60	8058093683879	
75cm	6,5mm	Pair 14,00mm	20cm	300WP75	8058093683886	

WILD

SIZE	SHAFT Ø	RUBBER Ø	RUBBER LENGHT	COD.	EAN	€
40cm	Prong	Circular 14,00mm	28cm	300W40	8058093683817	
50cm	Prong	Circular 14,00mm	32cm	300W50	8058093683831	
60cm	Prong	Circular 14,00mm	37cm	300W60	8058093683848	
75cm	Prong	Circular 14,00mm	46cm	300W75	8058093683855	





MADE IN ITALY

WILD CARBO



- Impugnatura con sistema di sgancio WILD
- Fusto 100% in carbonio diametro esterno 28mm
- Testata con ponticello
- Elastici S400 con boccola Filettata
- Asta tahitiana inox
- Appoggio sternale facilmente estraibile
- Predisposizione per mulinello Salvimar

- Handle with WILD trigger mechanism
- 100% Carbon barrel with outer diameter 28mm
- Muzzle removable bridge
- Screw in bands S400
- Inox Tahitian shaft
- Removable butt pad
- Reel mounted included

SIZE	SHAFT Ø	RUBBER Ø	RUBBER LENGHT	COD.	EAN	€
60cm	Ø 6,5mm	Pair 16,00mm	16cm	300C60	8058093686658	
75cm	Ø 6,5mm	Pair 16,00mm	20cm	300C75	8058093686665	
85cm	Ø 6,5mm	Pair 16,00mm	24cm	300C85	8058093686672	

WILD CARBO STONE



- Impugnatura con sistema di sgancio WILD
- Fusto 100% in carbonio diametro esterno 28mm
- Testata con ponticello
- Elastici S400 con boccola Filettata
- Asta tahitiana inox filettata + fiocina speed
- Appoggio sternale facilmente estraibile
- Predisposizione per mulinello Salvimar

- Handle with WILD trigger mechanism
- 100% Carbon stock with outer diameter 28mm
- Muzzle removable bridge
- Screw in bands S400
- Threaded stainless steel Tahitian shaft + speed prong
- Removable butt pad
- Reel mounted included

SIZE	SHAFT Ø	RUBBER Ø	RUBBER LENGHT	COD.	EAN	€
40cm	Ø 6,5mm	Pair 16,00mm	12 cm	300C40S	8056138180178	
50cm	Ø 6,5mm	Pair 16,00mm	14 cm	300C50S	8056138180185	
60cm	Ø 6,5mm	Pair 16,00mm	16 cm	300C60S	8056138180192	
75cm	Ø 6,5mm	Pair 16,00mm	20cm	300C75S	8056138180208	



MADE
IN ITALY

WILD CARBO OPEN



- Impugnatura con sistema di sgancio WILD
- Fusto 100% in carbonio diametro esterno 28mm
- Testata aperta multi elastico
- Elastico legato 16 mm con ogiva in Dyneema
- Asta capture da 6,5 mm
- Appoggio sternale facilmente estraibile
- Predisposizione per mulinello Salvimar

- Handle with WILD trigger mechanism
- 100% Carbon barrel with outer diameter 28mm
- Open muzzle multi band
- Dyneema soft wishbones 16 mm
- 6,5 mm Capture shaft
- Removable butt pad
- Reel mounted included

SIZE	SHAFT Ø	RUBBER Ø	RUBBER LENGHT	COD.	EAN	€
60cm	6,5mm	16,00mm	44cm	300CO60	8058093687525	
75cm	6,5mm	16,00mm	48cm	300CO75	8058093687532	
85cm	6,5mm	16,00mm	54cm	300CO85	8058093687549	



MADE
IN ITALY

POLE SPEAR 18



POLE SPEAR 18 + SLIP TIP

- Tubo in alluminio Ergal da \varnothing 18 mm est. e \varnothing 13 mm int.
- Propulsione generata tramite elastico a forza crescente
- Adatto alla cattura di grandi prede

- Aluminium Ergal anodized barrel 18mm OD and 13mm ID
- Aluminium Ergal tube \varnothing 18 mm ext. and \varnothing 13 mm int.
- Propulsion generated by elastic with increasing force
- Ideal for larger fish

SIZE	COD.	EAN	€
195cm HARPOON	301000/B	8057685557024	
195cm SLIP TIP	301000/BS	8056138188495	



HARPOON SPEAR PARTS - HARPOON POLE SPEAR 18

THREAD	COD.	EAN	€
M7	AC062/18	8057685557673	

SLIP TIP 3 SPEAR PARTS - ARPIONE SLIP TIP 3 POLE SPEAR 18

THREAD	COD.	EAN	€
M7	AC062/18ST-M7	8057685559295	

SPEAR PARTS - RUBBER FOR POLE SPEAR 18

DIAMETER	COD.	EAN	€
\varnothing 12mm external \varnothing 9mm internal	LELASPOL/18	8057685558274	

POLE SPEAR 14



POLE SPEAR 160cm + PARALYZER



POLE SPEAR 160cm + HARPOON

- Tubo in alluminio Ergal anodizzato da \varnothing 14 mm esterno e \varnothing 10 mm interno
- Propulsione tramite elastico
- Paralyzer Inox in dotazione
- Filettatura M6

- Ergal aluminium alloy anodized 14mm 2-piece pole-spear
- Stainless steel paralyzer tip
- M6 Thread

SIZE	COD.	EAN	€
POLE SPEAR 14 + PARALYZER	160cm 301000BK	8057685553057	
POLE SPEAR 14 + HARPOON	160cm 301000BKA	8056138183933	



MADE IN ITALY

POLE SPEAR 14 SHORT



POLE SPEAR 90cm SHORT + PARALYZER



POLE SPEAR 90cm SHORT + HARPOON

- Tubo in alluminio Ergal anodizzato da \varnothing 14 mm esterno e \varnothing 10 mm interno
- Propulsione tramite elastico
- Paralyzer Inox in dotazione
- Filettatura M6

- Ergal aluminium alloy anodized 14mm 2-piece pole-spear
- Stainless steel paralyzer tip
- M6 Thread

	SIZE	COD.	EAN	€
POLE SPEAR 14 SHORT + PARALYZER	90cm SHORT	301000S	8058093684951	
POLE SPEAR 14 SHORT + HARPOON	90cm SHORT	301000SA	8056138183940	



SPEAR PARTS - PARALYZER STAINLESS 3 PRONGS - POLE SPEAR 14

THREAD	LENGTH	COD.	EAN	€
M6	24cm	AA006	8057685550711	



SPEAR PARTS - POLE SPEAR 14 HARPOON

THREAD	COD.	EAN	€
M6	AC062	8057685550599	



SPEAR PARTS - RUBBER FOR POLE SPEAR 14

DIAMETER	COD.	EAN	€
\varnothing 9mm external \varnothing 6mm internal	LELSPOL	8057685558267	



SPEAR PARTS - RUBBER FOR POLE SPEAR 14 SHORT

DIAMETER	COD.	EAN	€
\varnothing 9mm external \varnothing 6mm internal	LELSPOL/S	8056138184411	

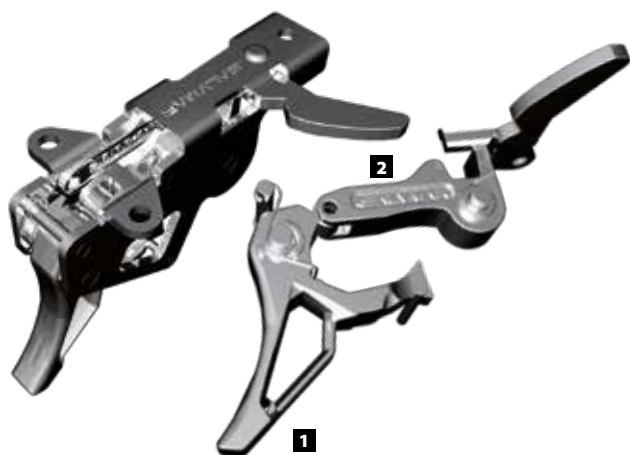

MECCANISMO DI SGANCIO HEAVY METAL HEAVY METAL TRIGGER MECHANISM

- Meccanismo di sgancio in acciaio Inox 100%
- Grilletto (1) e leva di sgancio (2) realizzati con tecnologia M.I.M
- Rotellina in acciaio 17-4ph trattato termicamente
- Carico testato 350 kg.
- 100% Stainless Steel mechanism
- Trigger (1) and Sear (2) produced entirely using MIM aka Metal Injection Molding technology
- Roller wheel for the sear made of 17-4Ph heat treated stainless
- Load tested to 350Kg's (732lbs)

COD.	EAN	€
301050	8058093683985	

DESCRIPTION	COLOR	COD.	EAN	€
IMPUGNATURA COMPLETA METAL COMPLETE HANDLE METAL		LVM0006	8057685559974	
IMPUGNATURA COMPLETA VOODOO COMPLETE HANDLE VOODOO		301006	8055960722761	
IMPUGNATURA COMPLETA WILD COMPLETE HANDLE WILD		LFUC17LVM	8058093686580	
CALCIO ERGONOMICO IN GOMMA ERGONOMIC RUBBER BUTT	BIANCO WHITE	301007	8055960722778	
CALCIO ERGONOMICO IN GOMMA ERGONOMIC RUBBER BUTT	NERO BLACK	301008	8055960722785	
CALCIO ERGONOMICO IN GOMMA ERGONOMIC RUBBER BUTT	ARANCIONE ORANGE	301008/A	8055960722792	
CALCIO ERGONOMICO IN GOMMA ERGONOMIC RUBBER BUTT	BLU BLUE	301008/B	8057685557741	
CALCIO ERGONOMICO IN GOMMA ERGONOMIC RUBBER BUTT	VERDE ACIDO ACID GREEN	301008/C	8057685557758	
APPOGGIO STERNALE REMOVABLE BUTT PAD.		301009	8055960722808	
CANNOTTO WILD WILD SHORT TUBE		301010	8055960722815	
CANNOTTO MULINELLO VOODOO VOODOO REEL SHORT TUBE		301011	8055960722822	
TESTATA VOODOO OPEN VOODOO OPEN MUZZLE		301013	8055960722846	
TESTATA METAL METAL MUZZLE		301013A	8057685556362	
TESTATA VOODOO VOODOO MUZZLE		301014	8055960722853	
TESTATA WILD WILD MUZZLE		301012	8055960722839	
PONTICELLO TESTATA VOODOO - KIT 5 PEZZI KIT 5 PIECES - VOODOO MUZZLE SHAFT BRIDGE		301015	8055960722860	
CANNOTTO TESTATA VOODOO VOODOO MUZZLE SHORT TUBE		301016	8055960722877	
NUOVO CANOTTO TESTATA 2023 2023 NEW MUZZLE SHORT TUBE		301016N	805613818855	

FUSTI VOODOO - METAL - WILD CARBO VOODOO - METAL - WILD CARBO BARREL

DESCRIPTION	SIZE	COD.	EAN	€
FUSTO VOODOO CILINDRICO / VOODOO ROUND ALUMINIUM BARREL	75 cm	LFUC100/V75	8055960725710	
FUSTO VOODOO CILINDRICO / VOODOO ROUND ALUMINIUM BARREL	85 cm	LFUC100/V85	8055960725711	
FUSTO VOODOO CILINDRICO / VOODOO ROUND ALUMINIUM BARREL	95 cm	LFUC100/V95	8055960725712	
FUSTO VOODOO CILINDRICO / VOODOO ROUND ALUMINIUM BARREL	105 cm	LFUC100/V105	8055960725713	
FUSTO METAL RAIL PRO /METAL ALLUMINIUM BARREL	75 cm	LVM0010/75	8057685559912	
FUSTO METAL RAIL PRO /METAL ALLUMINIUM BARREL	85 cm	LVM0010/85	8057685559929	
FUSTO METAL RAIL PRO /METAL ALLUMINIUM BARREL	95 cm	LVM0010/95	8057685559936	
FUSTO METAL RAIL PRO /METAL ALLUMINIUM BARREL	105 cm	LVM0010/105	8057685559943	
FUSTO METAL RAIL PRO /METAL ALLUMINIUM BARREL	115 cm	LVM0010/115	8057685559950	
FUSTO METAL RAIL PRO /METAL ALLUMINIUM BARREL	125 cm	LVM0010/125	8057685559967	
FUSTO ALLUMINIO VOODOO RAIL / VOODOO RAIL ALUMINIUM BARREL	75 cm	LFUC100/75	8055960725714	
FUSTO ALLUMINIO VOODOO RAIL / VOODOO RAIL ALUMINIUM BARREL	85cm	LFUC100/85	8055960725715	
FUSTO ALLUMINIO VOODOO RAIL / VOODOO RAIL ALUMINIUM BARREL	95 cm	LFUC100/95	8055960725716	
FUSTO ALLUMINIO VOODOO RAIL / VOODOO RAIL ALUMINIUM BARREL	105 cm	LFUC100/105	8057685559943	



- Tubo 100% Carbonio Pre-Peg TW-K03, realizzato a stampo in autoclave
- Diametro esterno 28mm - interno 25,7mm
- Sigillato con Tappi in gomma

- 100% Carbon Pre-Peg TW-K03 barrel, moulded in autoclave
- Internally filled with closed cell Polyurethane
- Sealed with Carbon walls

DESCRIPTION	SIZE	COD.	EAN	€
FUSTO WILD CARBO / WILD CARBO BARREL	40 cm	LFUC100/C40	8057685559240	
FUSTO WILD CARBO / WILD CARBO BARREL	50 cm	LFUC100/C50	8057685559275	
FUSTO WILD CARBO / WILD CARBO BARREL	60 cm	LFUC100/C60	8058093686610	
FUSTO WILD CARBO / WILD CARBO BARREL	75 cm	LFUC100/C75	8058093686627	
FUSTO WILD CARBO / WILD CARBO BARREL	85 cm	LFUC100/C85	8058093686634	
FUSTO WILD CARBO / WILD CARBO BARREL	95 cm	LFUC100/C95	8058093686641	
FUSTO WILD CARBO / WILD CARBO BARREL	105 cm	LFUC100/C105	8058093686597	
FUSTO WILD CARBO / WILD CARBO BARREL	115 cm	LFUC100/C115	8058093686603	



OLIO LUBRIFICANTE SPRAY

- Olio lubrificante per parti meccaniche di fucili subacquei
- **Descrizione:** Liquido idraulico ad alte prestazioni adatto a sistemi meccanici subacquei
- **Prestazioni:** Eccellenti proprietà antiusura, antiossidanti e anti corrosione. Grazie all'esclusiva formula antiattrito, SpearGun Oil, consente la formazione di uno strato lubrificante atto a ridurre l'attrito tra le parti meccaniche. Le prestazioni si mantengono elevate nel tempo e sin dalle prime applicazioni
- **Raccomandazioni:** Prima dell'applicazione, lavare con acqua dolce e lasciare asciugare le parti da lubrificare

- Lubricating oil for spearguns' mechanical parts.
- **Description:** High performance hydraulic oil for spearguns mechanism
- **Performance:** Thanks to the special antifriction compound, SpearGun Oil creates a coating lube that reduces friction between mechanical parts. High and long lasting performance from the first use. Exceptional antiwear, antioxidant and anti-corrosion capacity
- **Advices:** Wash with fresh water and dry the mechanical parts before applying the product

► Suggested Pack: 12 pz

ML.	COD.	EAN	€
30	400269	8056138180703	

TAPPO IN GOMMA

- Tappo in gomma per sigillatura fusti arbalette da Ø25mm a Ø27mm
- Rubber cap for sealing sling gun barrels from Ø25mm to Ø27mm



KIT	COD.	EAN	€
2PZ	LWI0001	8058093684319	



MAX REEL

- Materiale: nylon caricato vetro 30%
- Componenti in acciaio e Delrin
- Staffa guida sagola
- Compatibile con tutti gli arbalette Salvimar
- Componenti per l'assemblaggio di serie
- "Disegno e Concetto Tecnico sviluppato in Salvimar"

- 30% Fiberglass loaded nylon
- Components in stainless steel and Delrin
- Line Guide
- Compatible with all Salvimar spearguns
- Standard supplied components for assembly
- "Design & Technical Concept made in Salvimar"

CAPACITY	COD.	EAN	€
75m x 1,5mm	301005/D	8057685558984	



MINI REEL 50

- Materiale: nylon caricato vetro 30%
- Componenti in acciaio e Delrin
- Staffa guida sagola
- Compatibile con tutti gli arbalette Salvimar
- Componenti per l'assemblaggio di serie
- "Design & Technical Concept made in Salvimar"

- 30% Fiberglass loaded nylon
- Components in stainless steel and Delrin
- Line Guide
- Compatible with all Salvimar spearguns
- Standard supplied components for assembly
- "Design & Technical Concept made in Salvimar"

CAPACITY	COD.	EAN	€
50m x 1,0mm	301005/E	8058093683930	

VERTICAL REEL 70

- Mulinello verticale per arbalette
- Componenti in Acciaio, Nylon e Delrin
- Frizione e manettino di riavvolgimento separati
- Staffa guida sagola
- Compatibile con tutti gli arbalette Salvimar
- Componenti per l'assemblaggio di serie
- "Design & Technical Concept made in Salvimar"

- Vertical Reel
- Stainless steel, Nylon and Delrin components.
- Separate drag and handle for winding
- Line Guide
- Compatible with all Salvimar spearguns
- Standard supplied components for assembly
- "Design & Technical Concept made in Salvimar"



LIME - BROWN



RED

CAPACITY	COLOR	COD.	EAN	€
70m x 1,5mm	BLACK	301005/F	8058093683947	
70m x 1,5mm	LIME - BROWN	301005/F/L	8058093688850	
70m x 1,5mm	RED - BLACK	301005/F/R	8058093688843	

MICRO VERTICAL REEL

- Mulinello MICRO verticale per arbalette
- Componenti in Alluminio anodizzato nero, Nylon e Delrin
- Frizione e manettino di riavvolgimento separati
- Staffa guida sagola
- Compatibile con tutti gli arbalette Salvimar
- Componenti per l'assemblaggio di serie
- "Design & Technical Concept made in Salvimar"

- MICRO Vertical Reel
- Black anodized Aluminium, Nylon and Delrin components
- Separate drag and handle for winding
- Line Guide
- Compatible with all Salvimar spearguns
- Standard supplied components for assembly
- "Design & Technical Concept made in Salvimar"



CAPACITY	COD.	EAN	€
50m x 1,2mm	301005/C	8056138188457	



STAFFA IN ALLUMINIO ANODIZZATO NERO

ADATTATORI (MAX REEL - MINI REEL 50 - VERTICAL REEL 70 - MICRO VERTICAL REEL)

- Adattatore in NYLON caricato vetro che permette l'utilizzo della gamma mulinelli SALVIMAR su supporto originale Omer e Cressi

- Fiberglass loaded NYLON adapter that allows the use of SALVIMAR on original Omer and Cressi support

	COD.	EAN	€
OMER	LMULINMAX20	8058093682186	
CRESSI	LMULINMAX21	8058093682193	



UNIVERSAL REEL

- Mulinello universale con adattatore

- Universal reel with adapter

CAPACITY	COD.	EAN	€
50m x 1,5mm	AP050	8055960725540	



STAFFA ACTION CAM2 ALLUMINIO



- Staffa videocamera doppia in alluminio
- Orientabile e removibile
- Compatibile con tutti gli arbalete Salvimar

- Double video camera bracket in aluminum
- Adjustable and removable
- Compatible with all Salvimar spearguns

COLOR	COD.	EAN	€
Black	LHR0060A	8056138180949	

STAFFA ALLUMINIO



- Staffa videocamera doppia in alluminio
- Compatibile con tutti gli arbalete Salvimar

- Double video camera bracket in aluminum
- Compatible with all Salvimar spearguns

COLOR	COD.	EAN	€
Black	LHR0040A	8056138180994	

STAFFA ACTION CAM2



- Staffa videocamera doppia in acciaio INOX 304
- Orientabile e removibile
- Compatibile con tutti gli arbalete Salvimar

- Double video camera bracket in stainless steel 304
- Adjustable and removable
- Compatible with all Salvimar spearguns

COLOR	COD.	EAN	€
	LHR0060	8058093687723	

STAFFA INOX



- Staffa per videocamera in acciaio INOX 304
- Compatibile con tutti gli arbalete Salvimar

- Stainless steel 304 bracket for camera
- Compatible with all Salvimar spearguns

COLOR	COD.	EAN	€
	LHR0040	8058093687129	



LFUC25



UNICLAMP

- Staffa universale per montare mulinelli ed altri accessori su tubi da Ø28 a 40 mm

- Universal clamp for mounting reels and other accessories on tubes from Ø28 to 40 mm

KIT	COD.	EAN	€
	400280	8055960726783	
3 pieces	LFUC25	8057685557031	

SALVIMAR by Primeline

Salvimar by Primeline, elastico in lattice naturale di elevata qualità prodotto dalla **Primeline Industries U.S.A.**, offre altissime prestazioni.

La gomma ricavata dal lattice naturale è diversa da quella ricavata da materiali estrusi o sintetici. Primeline utilizza un "procedimento d' immersione continua" in cui la gomma viene costruita in un processo a strati che offre proprietà fisiche elevate con meno di 50 microgrammi di proteine per grammo. Estratto dall'albero *Hevea Brasiliensis* viene lavorato nella forma liquida originale, ottenendo una formula uniformemente distribuita. Il risultato è un prodotto con proprietà fisiche superiori, tra cui una maggiore resistenza alla lacerazione. Queste caratteristiche sono essenziali per fornire all'elastico Salvimar by Primeline maggiore forza e prestazioni superiori. Salvimar offre ai suoi clienti produzioni **PRIMELINE** dedicate e realizzate appositamente per la nostra azienda con una scelta accurata delle mescole e degli spessori.

Le mescole **Salvimar by Primeline** sono di tre diverse tipologie: **HURRICANE**, **PRIME** e **OPTIMUS**. Ognuna di loro ha caratteristiche tecniche diverse per adattarsi ad ogni esigenza del pescatore in apnea.

HURRICANE, la mescola compatta dall'elevata durezza è sviluppata per mantenere invariata la potenza dopo che il fucile è stato caricato. Consigliato per la pesca all'aspetto e per chi predilige reattività ed esplosività.

PRIME, formula studiata per ottenere un modulo elastico ottimizzato che garantisca un ottimo rapporto tra sforzo di caricamento e restituzione di potenza. Questo rende la mescola **PRIME** versatile e adatta a tutti i tipi di pesca.

OPTIMUS, Mescola più morbida: garantisce una spinta progressiva e costante, e consente di poter accorciare la lunghezza standard dell'elastico su fuclci a canna corta per aumentarne la potenza. Facilita il caricamento del fuclce.

Il processo produttivo permette di scegliere la dimensione del foro: l'ID, che può essere, **STANDARD ID 3,2mm** o **MICRO ID 1,6mm**.

L'elastico dal diametro interno standard ID da 3,2mm ha un'ottimo rapporto tra forza di carico e potenza erogata. La scelta del diametro più piccolo MICRO ID 1,6mm consente di aumentare la potenza dell'elastico a parità di ingombro esterno, facilitando il brandeggio durante l'azione di pesca.

Salvimar by Primeline, natural latex rubber band of the highest quality produced by **Primeline Industries U.S.A.**, offers very high performance.

Rubber made from natural latex is different from rubber made from extruded or synthetic materials. Primeline uses a "continuous immersion process" in which the rubber is built in a layered process that offers high physical properties with less than 50 micrograms of protein per gram. Extracted from the *Hevea Brasiliensis* tree, it is processed in the original liquid form and avoids the chewing process, resulting in an evenly distributed formula. The result is a product with superior physical properties including higher tear resistance. These features are essential to provide the Salvimar by Primeline elastic band with greater strength and higher performance. Salvimar offers its customers dedicated **PRIMELINE** productions made specifically for our company with an accurate choice of compounds and thicknesses.

Salvimar by Primeline compounds are of three different types: **HURRICANE**, **PRIME** and **OPTIMUS**. Each of them has different technical characteristics to adapt to each spearfisher's need.

HURRICANE, the compact compound with high hardness is developed to maintain power unchanged after the speargun has been loaded. Recommended for spearfishing with the waiting technique and for those who prefer reactivity and explosiveness.

PRIME, formula designed to obtain an optimized elastic modulus that guarantees an excellent ratio between loading effort and power return. This makes the **PRIME** compound versatile and suitable for all types of fishing.

OPTIMUS, Softer compound: ensures a progressive and constant thrust, and allows to shorten the standard length of the rubber band on short-barrelled spearguns to increase their power. It facilitates the speargun loading.

The production process allows to choose the bore size: the ID, which can be **STANDARD ID 3.2mm** or **MICRO ID 1.6mm**.

The rubber band with standard 3.2mm ID (inner diameter) has an excellent ratio between load force and power delivered. The choice of the smaller diameter MICRO ID 1.6mm allows to increase the power of the rubber band with the same external dimensions, facilitating the swinging during the fishing action.



HURRICANE ACID GREEN
micro ID

Ø 14,5 mm
Ø 16 mm



PRIME BLACK
standard ID

Ø 14,5 mm
Ø 16 mm



PRIME BLACK
micro ID

Ø 14,5 mm
Ø 16 mm



OPTIMUS OLIVE GREEN
standard ID

Ø 16 mm
Ø 17,5 mm



DIAMETER	COMPOUND	ID / Ø	COLOR	PACK	COD.	EAN	€
Ø14,5 mm*	Hurricane	micro ID Ø 1,6mm	acid green	15m	E145B3P	8056138182219	
Ø16 mm*	Hurricane	micro ID Ø 1,6mm	acid green	15m	E160B3P	8056138182233	
Ø14,5 mm*	Prime	standard ID Ø 3,2mm	black	15m	E145B2G	8056138182134	
Ø16 mm*	Prime	standard ID Ø 3,2mm	black	15m	E160B2G	8056138182172	
Ø14,5 mm*	Prime	micro ID Ø 1,6mm	black	15m	E145B2P	8056138182158	
Ø16 mm*	Prime	micro ID Ø 1,6mm	black	15m	E160B2P	8056138182196	
NEW Ø16 mm*	Optimus	standard ID Ø 3,2mm	olive green	15 m	E160B1G	8056138184558	
Ø17,5 mm*	Optimus	standard ID Ø 3,2mm	olive green	12 m	E175B1G/12	8056138182110	
Ø14,5 mm*	Hurricane	micro ID Ø 1,6mm	acid green	1,5m	E145K3P	8056138184015	
Ø16 mm*	Hurricane	micro ID Ø 1,6mm	acid green	1,5m	E160K2P	8056138184039	
Ø14,5 mm*	Prime	standard ID Ø 3,2mm	black	1,5m	E145K2G	8056138183995	
Ø16 mm*	Prime	standard ID Ø 3,2mm	black	1,5m	E160K2G	8056138184022	
Ø14,5 mm*	Prime	micro ID Ø 1,6mm	black	1,5m	E145K2P	8056138184008	
Ø16 mm*	Prime	micro ID Ø 1,6mm	black	1,5m	E160K2P	8056138184039	
NEW Ø16 mm*	Optimus	standard ID Ø 3,2mm	olive green	1,5m	E160K1G	8056138184565	
Ø17,5 mm*	Optimus	standard ID Ø 3,2mm	olive green	1,5m	E175K1G	8056138184053	

* Diametro minimo garantito

SALVIMAR RUBBERS

- 100% lattice Malese
- Miscela con aggiunta di additivo anti-invecchiamento per conferire maggiore durata nel tempo
- **Processo produttivo prevede:**
 - 1 Trafilatura: questa tecnologia garantisce costanza di diametro e quindi assicura costanza di prestazioni
 - 2 Passaggio nel tunnel di Pre-Vulcanizzazione
 - 3 Primo Controllo qualità
 - 4 Primo trattamento con componente siliconico
 - 5 Vulcanizzazione: asciugatura lenta in forno a temperatura costante per 2/5gg
 - 6 Trattamento siliconico manuale
 - 7 Controllo qualità finale
- **Trattamento siliconico.** Il silicone penetra e si consolida sulla superficie formando una barriera protettiva contro raggi UV ed agenti esterni
- Per aumentare l'efficienza del prodotto si consiglia di proteggere l'elastico trattandolo con silicone liquido, periodicamente
- BOX garantito 15mt in continuo

- 100% Malaysian latex
- Mixture with added anti-ageing additive to provide greater durability
- **The production process includes:**
 - 1 drawing: this technology guarantees a constant diameter and therefore ensures consistency of performance
 - 2 processing in the Pre-Vulcanisation tunnel
 - 3 First Quality Control
 - 4 First treatment with silicone component
 - 5 Vulcanization: slow drying in oven at constant temperature for 2/5 days
 - 6 Manual silicone treatment
 - 7 Final quality check
- **Silicone treatment.** The silicone penetrates and consolidates on the surface forming a protective barrier against UV rays and external agents.
- To increase the efficiency of the product it is recommended to protect the rubber by treating it with liquid silicone periodically recommended
- BOX guaranteed 15mt continuously



FLUO RED

Ø 15 mm
Ø 17 mm



BLACK

Ø 14 mm
Ø 16 mm
Ø 18 mm



ACID GREEN

Ø 14 mm
Ø 16 mm



SHINING BLUE

Ø 16 mm





DIAMETER Ø	COLOR	PACK	COD.	EAN	€
14 mm	black	15m	500100/Z	8055960723041	
14 mm	acid green	15m	500100/ZG	8057685557369	
15 mm	fluo red	15m	500100/FZR	8058093686337	
16 mm	black	15m	500100/A	8055960722983	
16 mm	acid green	15m	500100/AGS	8058093683961	
16 mm	shining blue	15m	500100/SB	8058093683954	
17 mm	fluo red	15m	500100/FAR	8058093686320	
18 mm	black	15m	500100/B	8055960723003	





DIAMETER Ø	COLOR	PACK	COD.	EAN	€
14 mm	black	1,5m	500100/Z1	8058093688362	
14 mm	acid green	1,5m	500100/ZG1	8058093684968	
15 mm	fluo red	1,5m	500100/FR1	8058093687785	
16 mm	black	1,5m	500100/A1	8058093688379	
16 mm	acid green	1,5m	500100/AGS1	8058093684975	
16 mm	shining blue	1,5m	500100/SB1	8058093684982	
16 mm	military green	1,5m	500100/AM1	8058093684999	
17 mm	fluo red	1,5m	500100/FAR1	8058093688355	
18 mm	black	1,5m	500100/B1	8058093688386	

EPTAGUM 600

- EPTAGUM 600 : nuovo esclusivo elastico a sezione eptagonale e spigoli smussati
- 100% Lattice naturale malese
- Produzione ricerca e sviluppo italiani
- Disponibile in due sezioni con diametro inscritto 14 e 16 mm, e due colorazioni.

La nuova mescola 600 frutto dello studio del R&D Salvimar, ottimizzata per avere migliori prestazioni di carico sia istantanee che, grazie alle sue specifiche proprietà di memoria, dopo periodi prolungati di stress. Test prestazionali hanno evidenziato un incremento generale delle prestazioni di oltre il 10% rispetto ad una mescola tradizionale. Particolarmente evidente è l'incremento ottenuto in termini di velocità di contrazione dell'elastico, frutto dell'esplosività ottenuta senza pregiudicare la tradizionale fluidità delle mescole Salvimar.

- EPTAGUM 600 new exclusive rubber with heptagonal section with rounded edges
- 100% Malaysian natural latex
- Italian R&D production
- Available in two sections with inscribed diameter 14 and 16 mm, and two colours

The new 600 compound, the result of the Salvimar R&D study, optimised for improved load performance both instantaneously and, thanks to its specific memory properties, after prolonged periods of stress, performance tests have shown a general increase in performance of over 10% compared to a traditional compound. Particularly evident is the increase obtained in terms of the contraction rate of the rubber, the result of the explosiveness obtained without affecting the traditional fluidity of Salvimar compounds.



LIME



BLACK

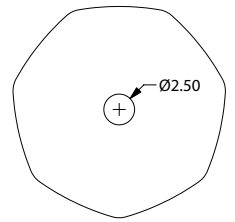

	COLOR	PACK	COD.	EAN	€
SMTP145	lime	15m	500100/E14	8058093688874	
SMTP160	lime	15m	500100/E16	8058093688881	
SMTP145	black	15m	500100/EB14	8058093689635	
SMTP160	black	15m	500100/EB16	8058093689642	



	COLOR	PACK	COD.	EAN	€
SMTP145	lime	1,5m	500100/E14/1	8058093688898	
SMTP160	lime	1,5m	500100/E16/1	8058093688904	
SMTP145	black	1,5m	500100/EB14/1	8058093689659	
SMTP160	black	1,5m	500100/EB16/1	8058093689666	

UV RUBBER CARE SILICONE SPRAY



- Protettivo silicico a base d'acqua per elastici in lattice.
- Protegge dai raggi UV lasciando una speciale pellicola protettiva sulla superficie
- **Modalità d'uso:** vaporizzare il prodotto sulle parti da lubrificare e proteggere; lasciare agire fino alla successiva immersione
- **Composizione:** emulsione silicica. Prodotto non pericoloso in conformità con il D.L. 65/03 e suoi relativi emendamenti

- Water-based silicone protection for latex rubbers.
- It protects from UV rays by leaving a special protective film on the surface
- **How to use:** Spray the product on the parts to be lubricated and protected; leave to act until the next dive
- **Composition:** silicone emulsion. Non-hazardous product in accordance with Decree Law no. 65/03 and amendments thereto

► Suggested Pack: 12 pz

ML.	COD.	EAN	€
60	400268	8056138180697	

DISPLAY SALVIMAR *by Primeline*

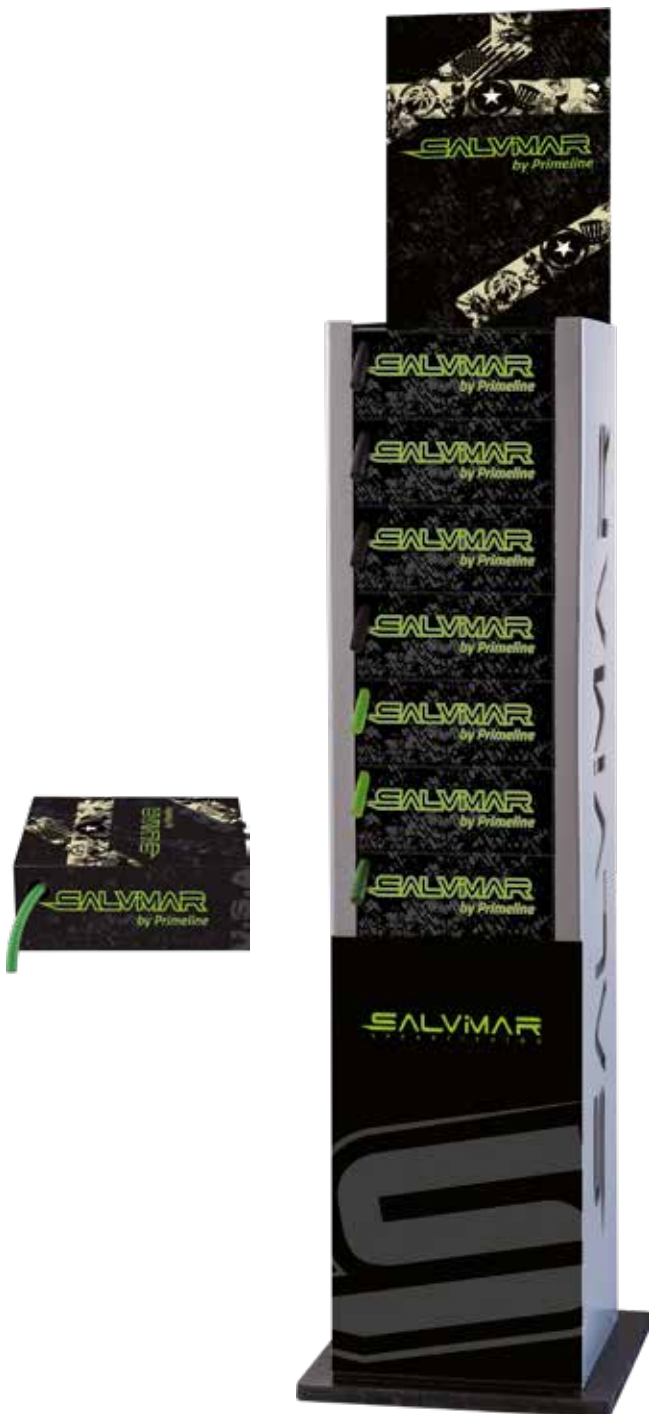

- Espositore elastici serie **SALVIMAR by Primeline**, comprensivo di:
n° 7 box elastici, pack 15 m, nei Ø 14,5mm black standard ID, micro ID e Hurricane acid green, Ø 16mm black standard ID micro ID e Hurricane acid green, Ø 17,5mm Optimus olive green
- Display for **SALVIMAR by Primeline** rubber boxes, includes:
7 boxes of 15 mt rubber each one. Ø 14,5mm black standard ID, micro ID e Hurricane acid green, Ø 16mm black standard ID micro ID e Hurricane acid green, Ø 17,5mm Optimus olive green

COD.

IMBSAL020P

EAN

8056138184343

€

DISPLAY **S400**

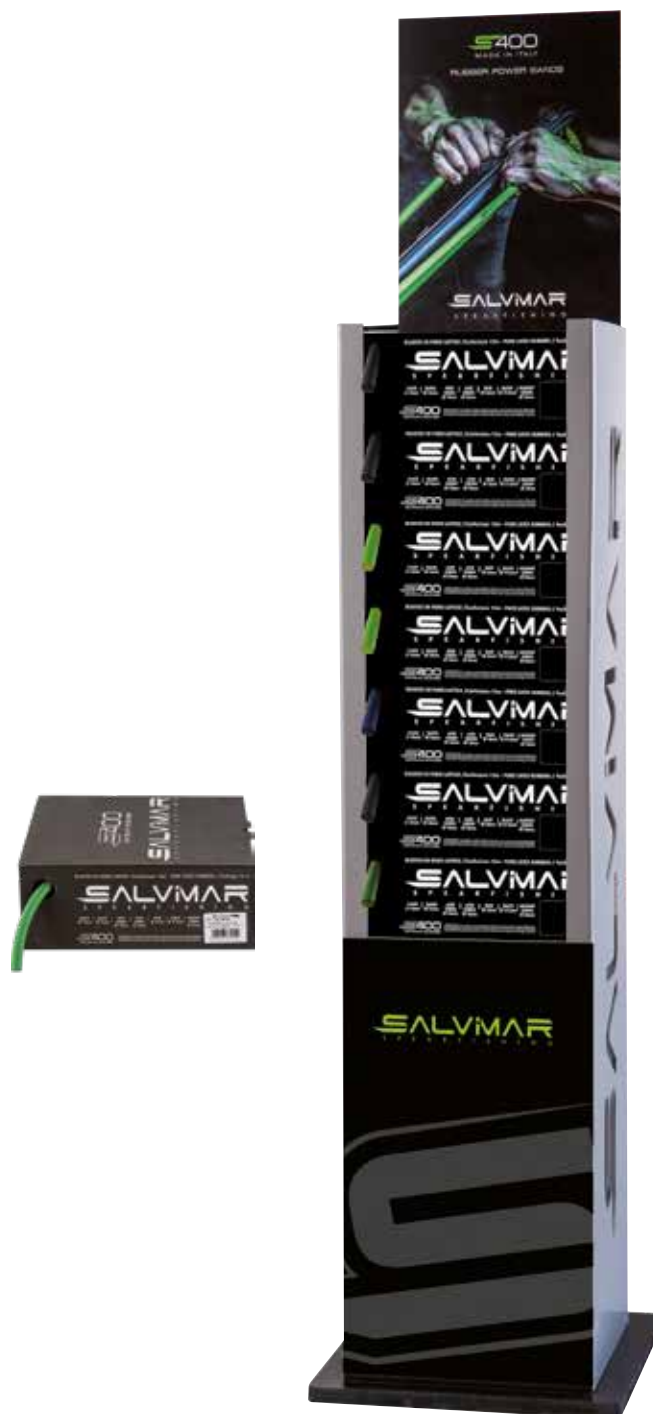

- Espositore elastici serie **S400**, made in Italy, comprensivo di:
n° 7 box elastici, pack 15 m, nei Ø 15mm red, Ø 17mm red, Ø 14mm acid green, black - Ø 16mm acid green, shining blue - Ø 18mm black
- Display for **S400** rubber boxes. Made in Italy. Includes:
7 boxes of 15 mt rubber each one. Ø 15mm red, Ø 17mm red, Ø 14mm acid green, black - Ø 16mm acid green, shining blue - Ø 18mm black

COD.

IMBSAL020

EAN

8058093684180

€

S400 PAIRS RUBBER WITH SCREWS

- Coppie di elastici imboccolati

- Pairs of rubbers



Ø	COLOR	RUBBER LENGHT	SPEARGUN	PACK	COD.	EAN	€
16,00mm	black	10cm	35cm	1pair	500110/A	8055960723065	
16,00mm	black	12cm	40cm	1pair	500120/A	8055960723072	
16,00mm	black	14cm	55cm	1pair	500140/A	8055960723102	
16,00mm	black	16cm	60cm	1pair	500160/A	8055960723133	
16,00mm	black	18cm	70cm	1pair	500180/A	8055960723164	
16,00mm	black	20cm	75cm	1pair	500200/A	8055960723195	
16,00mm	black	22cm	80cm	1pair	500220/A	8055960723232	
16,00mm	black	24cm	85cm	1pair	500240/A	8055960723270	
16,00mm	black	26cm	90cm	1pair	500260/A	8055960723317	
16,00mm	black	28cm	100cm	1pair	500280/A	8055960723355	
17,50mm	black	14cm	55cm	1pair	500140/B	8055960723119	
17,50mm	black	18cm	60cm	1pair	500180/B	8055960723171	
17,50mm	black	20cm	65cm	1pair	500200/B	8055960723201	
17,50mm	black	22cm	75cm	1pair	500220/B	8055960723249	
17,50mm	black	24cm	85cm	1pair	500240/B	8055960723287	
17,50mm	black	26cm	95cm	1pair	500260/B	8055960723324	
17,50mm	black	28cm	100cm	1pair	500280/B	8055960723362	
17,50mm	black	30cm	105cm	1pair	500300/B	8055960723409	

S400 PAIRS RUBBER WITH SCREWS ACID GREEN

Ø	COLOR	RUBBER LENGHT	SPEARGUN	PACK	COD.	EAN	€
14,00mm	acid green	12cm	40cm	1pz	500120/ZG	8058093686955	
14,00mm	acid green	14cm	50cm	1pz	500140/ZG	8058093686979	
14,00mm	acid green	16cm	60cm	1pz	500160/ZG	8058093686962	
14,00mm	acid green	20cm	75cm	1pz	500200/ZG	8058093686986	
16,00mm	acid green	14cm	55cm	1pair	500140/AG	8058093683992	
16,00mm	acid green	16cm	60cm	1pair	500160/AG	8058093684005	
16,00mm	acid green	18cm	70cm	1pair	500180/AG	8058093684012	
16,00mm	acid green	20cm	75cm	1pair	500200/AG	8058093684029	
16,00mm	acid green	22cm	80cm	1pair	500220/AG	8058093684036	
16,00mm	acid green	24cm	85cm	1pair	500240/AG	8058093684043	
16,00mm	acid green	26cm	90cm	1pair	500260/AG	8058093684050	

S400 CIRCULAR RUBBER WITH SCREWS

- Elastico circolare imboccolato

- Rubbers with screws



Ø	COLOR	RUBBER LENGHT	SPEARGUN	PACK	COD.	EAN	€
14,00mm	black	26cm	40cm	1pz	510260/Z	8055960723461	
14,00mm	black	28cm	55cm	1pz	510280/Z	8055960723485	
14,00mm	black	32cm	65cm	1pz	510320/Z	8055960723515	
14,00mm	black	37cm	70cm	1pz	510370/Z	8055960723546	
14,00mm	black	40cm	75cm	1pz	510400/Z	8055960723584	
14,00mm	black	46cm	80cm	1pz	510460/Z	8055960723638	
14,00mm	black	50cm	85cm	1pz	510500/Z	8055960723676	
14,00mm	black	56cm	90cm	1pz	510560/Z	8055960723737	
14,00mm	black	60cm	95cm	1pz	510600/Z	8058093684098	
14,00mm	black	65cm	105cm	1pz	510650/Z	8057685556188	
16,00mm	black	28cm	50cm	1pz	510280/A	8055960723478	
16,00mm	black	32cm	55cm	1pz	510320/A	8055960723508	
16,00mm	black	37cm	60cm	1pz	510370/A	8055960723539	
16,00mm	black	40cm	65cm	1pz	510400/A	8055960723560	
16,00mm	black	43cm	70cm	1pz	510430/A	8055960723591	
16,00mm	black	46cm	75cm	1pz	510460/A	8055960723621	
16,00mm	black	50cm	85cm	1pz	510500/A	8055960723669	
16,00mm	black	56cm	95cm	1pz	510560/A	8055960723720	
16,00mm	black	60cm	105cm	1pz	510600/A	8055960723751	
17,50mm	black	33cm	50cm	1pz	510330/B	8055960723522	
17,50mm	black	40cm	60cm	1pz	510400/B	8055960723577	
17,50mm	black	43cm	65cm	1pz	510430/B	8055960723607	
17,50mm	black	45cm	70cm	1pz	510450/B	8055960723614	
17,50mm	black	48cm	75cm	1pz	510480/B	8055960723645	
17,50mm	black	52cm	80cm	1pz	510520/B	8055960723683	
17,50mm	black	55cm	85cm	1pz	510550/B	8055960723713	
17,50mm	black	58cm	90cm	1pz	510580/B	8055960723744	
17,50mm	black	65cm	95cm	1pz	510650/B	8055960723782	

S400 CIRCULAR RUBBER WITH SCREWS ACID GREEN

Ø	COLOR	RUBBER LENGHT	SPEARGUN	PACK	COD.	EAN	€
14,00mm	acid green	28cm	40cm	1pz	510280/ZG	8058093686801	
14,00mm	acid green	32cm	50cm	1pz	510320/ZG	8058093686818	
14,00mm	acid green	37cm	60cm	1pz	510370/ZG	8058093686825	
14,00mm	acid green	46cm	75cm	1pz	510460/ZG	8058093686832	

SALVIMAR by Primeline WISHBONE

AVAILABLE 2024



- Elastici legati

- Rubber dyneema wishbone

ID	Ø	COLOR	COMPODS	RUBBER LENGHT	SPEARGUN	PACK	COD.	EAN	€
3,2	14,50mm	black	PRIME	44cm	60cm	1pz	E1452G44	8056138188099	
3,2	14,50mm	black	PRIME	48cm	75cm	1pz	E1452G48	8056138188105	
3,2	14,50mm	black	PRIME	54cm	85cm	1pz	E1452G54	8056138188112	
3,2	14,50mm	black	PRIME	60cm	95cm	1pz	E1452G60	8056138188129	
3,2	14,50mm	black	PRIME	64cm	105cm	1pz	E1452G64	8056138188136	
3,2	14,50mm	black	PRIME	70cm	115cm	1pz	E1452G70	8056138188143	
3,2	14,50mm	black	PRIME	75cm	125cm	1pz	E1452G75	8056138188150	
3,2	16,00mm	black	PRIME	48cm	75cm	1pz	E1602G48	8056138188266	
3,2	16,00mm	black	PRIME	54cm	85cm	1pz	E1602G54	8056138188273	
3,2	16,00mm	black	PRIME	60cm	95cm	1pz	E1602G60	8056138188280	
3,2	16,00mm	black	PRIME	64cm	105cm	1pz	E1602G64	8056138188297	
3,2	16,00mm	black	PRIME	70cm	115cm	1pz	E1602G70	8056138188303	
3,2	16,00mm	black	PRIME	75cm	125cm	1pz	E1602G75	8056138188310	
1,6	14,50mm	acid green	HURRICANE	44cm	60cm	1pz	E1453P44	8056138188167	
1,6	14,50mm	acid green	HURRICANE	48cm	75cm	1pz	E1453P48	8056138188174	
1,6	14,50mm	acid green	HURRICANE	54cm	85cm	1pz	E1453P54	8056138188181	
1,6	14,50mm	acid green	HURRICANE	60cm	95cm	1pz	E1453P60	8056138188198	
1,6	14,50mm	acid green	HURRICANE	64cm	105cm	1pz	E1453P64	8056138188204	
3,2	16,00mm	olive green	OPTIMUS	48cm	75cm	1pz	E1601G48	8056138188211	
3,2	16,00mm	olive green	OPTIMUS	54cm	85cm	1pz	E1601G54	8056138188228	
3,2	16,00mm	olive green	OPTIMUS	60cm	95cm	1pz	E1601G60	8056138188235	
3,2	16,00mm	olive green	OPTIMUS	64cm	105cm	1pz	E1601G64	8056138188242	
3,2	16,00mm	olive green	OPTIMUS	70cm	115cm	1pz	E1601G70	8056138188259	

AVAILABLE 2024

AVAILABLE 2024

400 DYNEEMA WISHBONE



- Elastici legati

- Rubber dyneema wishbone

Ø	COLOR	RUBBER LENGHT	SPEARGUN	PACK	COD.	EAN	€
14,00mm	black	44cm	60cm	1pz	511010Z44	8058093688744	
14,00mm	black	48cm	75cm	1pz	511010Z48	8057685551398	
14,00mm	black	54cm	85cm	1pz	511010Z54	8057685551404	
14,00mm	black	60cm	95cm	1pz	511010Z60	8057685551343	
14,00mm	black	64cm	105cm	1pz	511010Z64	8057685551428	
14,00mm	black	70cm	115cm	1pz	511010Z70	8057685551435	
14,00mm	black	75cm	125cm	1pz	511010Z75	8057685551510	
14,00mm	black	80cm	135cm	1pz	511010Z80	8057685554344	
14,00mm	black	85cm	145cm	1pz	511010Z85	8057685554351	
16,00mm	black	44cm	60cm	1pz	511010A44	8058093681707	
16,00mm	black	48cm	75cm	1pz	511010A48	8058093681066	
16,00mm	black	54cm	85cm	1pz	511010A54	8058093681073	
16,00mm	black	60cm	95cm	1pz	511010A60	8058093681080	
16,00mm	black	64cm	105cm	1pz	511010A64	8058093681097	
16,00mm	black	70cm	115cm	1pz	511010A70	8058093681103	
16,00mm	black	75cm	125cm	1pz	511010A75	8058093681110	
16,00mm	black	80cm	135cm	1pz	511010A80	8058093682315	
14,00mm	acid green	44cm	60cm	1pz	511010Z44G	8056138180055	
14,00mm	acid green	48cm	75cm	1pz	511010Z48G	8058093689581	
14,00mm	acid green	54cm	85cm	1pz	511010Z54G	8058093689598	
14,00mm	acid green	60cm	95cm	1pz	511010Z60G	8058093689604	
14,00mm	acid green	64cm	105cm	1pz	511010Z64G	8058093689611	
16,00mm	shining blue	54cm	85cm	1pz	511010A54SB	8056138181380	
16,00mm	shining blue	60cm	95cm	1pz	511010A60SB	8056138181410	
16,00mm	shining blue	64cm	105cm	1pz	511010A64SB	8056138181403	
16,00mm	shining blue	70cm	115cm	1pz	511010A70SB	8056138181397	

EPTAGUM 600 SMTP165 DYNEMA WISHBONE



- Elastici legati

- Rubber dyneema wishbone

COLOR	RUBBER LENGHT	SPEARGUN	PACK	COD.	EAN	€
SMTP165	black	48cm	75cm	1pz	51E165B48	8056138183353
SMTP165	black	54cm	85cm	1pz	51E165B54	8056138183360
SMTP165	black	60cm	95cm	1pz	51E165B60	8056138183377
SMTP165	black	64cm	105cm	1pz	51E165B64	8056138183384

EPTAGUM 600 SMTP145 DYNEMA WISHBONE



COLOR	RUBBER LENGHT	SPEARGUN	PACK	COD.	EAN	€
SMTP145	lime	44cm	60cm	1pz	51E145L44	8058093689895
SMTP145	lime	48cm	75cm	1pz	51E145L48	8058093689888
SMTP145	lime	54cm	85cm	1pz	51E145L54	8058093689901
SMTP145	lime	60cm	95cm	1pz	51E145L60	8058093689918
SMTP145	lime	64cm	105cm	1pz	51E145L64	8058093689925
SMTP145	lime	70cm	115cm	1pz	51E145L70	8058093689932
NEW SMTP145	black	48cm	75cm	1pz	51E145B48	8056138184831
NEW SMTP145	black	54cm	85cm	1pz	51E145B54	8056138184848
NEW SMTP145	black	60cm	95cm	1pz	51E145B60	8056138184855
NEW SMTP145	black	64cm	105cm	1pz	51E145B64	8056138184862



BUNGEE

- Elastico cavo in puro lattice, per parastrappi ed ammortizzatori

- Pure latex tubing to make shock absorber and bungee

Ø	KIT	COD.	EAN	€
9mm	15mt	400261	8055960724963	
9mm	15mt	400261R	8058093688911	
12mm	15mt	400266	8058093688928	
12mm	15mt	400266R	8058093688935	



KIT RUBBER TOMAHAWK

- Elastici superiori S400 Ø 16mm ad allungamento controllato mediante, anima interna in sagola Dyneema®, 250kg di carico di rottura n° 4 elastici supplementari in linea S400R Ø 15mm

- Upper rubbers S400 Ø 16mm with elongation controlled by inner core in Dyneema® line, tensile strength 250kg # 4 additional S400R rubbers in line Ø 15mm

SIZE	RUBBER LENGHT	COD.	EAN	€
65cm	2 black Ø16mmx22cm + 4 red Ø15mmx18cm	512T065	8058093688416	
75cm	2 black Ø16mmx24cm + 4 red Ø15mmx20cm	512T075	8058093687617	
85cm	2 black Ø16mmx27cm + 4 red Ø15mmx23cm	512T085	8058093687624	
95cm	2 black Ø16mmx30cm + 4 red Ø15mmx26cm	512T095	8058093687631	
105cm	2 black Ø16mmx33cm + 4 red Ø15mmx28cm	512T105	8058093687648	
115cm	2 black Ø16mmx35cm + 4 red Ø15mmx31cm	512T115	8058093687655	
125cm	2 black Ø16mmx38cm + 4 red Ø15mmx34cm	512T125	8058093687662	
135cm	2 black Ø16mmx41cm + 4 red Ø15mmx37cm	512T135	8058093688805	



KIT ALLESTIMENTO ARBALETE

- Kit allestimento arbalete composto da:
Monofilo acyd green 15mt + 6 sleeves
Tendisagola
Sagola Acydine da 50mt Ø 1,3mm
Snap clip

- Sling gun set-up kit consisting of:
Acyd green monofilament line, 15mt + 6 sleeves
Line tensioner
Acydine line, 50mt Ø 1,3mm
Snap clip

COD.	EAN	€
400700	8058093688294	



KIT ALLESTIMENTO ARBALETE PRO

- Kit allestimento arbalete PRO composto da:
Monofilo tripla forza 6mt + sleeves
Tendisagola
Sagola Cymax da 50mt Ø 1,25mm
Snap clip

- Sling gun PRO set-up kit consisting of:
Triple strength Amonofilament line, 6mt + 6 sleeves
Line tensioner
Cymax line, 50mt Ø 1.25mm
Snap clip

COD.	EAN	€
400701	8058093688300	



SHOCK ABSORBER

- Ammortizzatore in gomma per arbalete. Impedisce lo strappo e/o rottura del monofilamento

- Rubber shock absorber for speargun. Preventing strain and breakage of the shaft line

COLOR	COD.	EAN	€
RED	400263R	8058093688737	
BLACK	400263	8057685559981	



ELASTICO FACILITATORE

- Elastico facilitatore

- Bands for loading support

COD.	EAN	€
303010	8058093682278	

TENDISAGOLA



KIT	COD.	EAN	€
10pz	400262	8055960724970	

TENDISAGOLA ALLESTITO



COD.	EAN	€
LNEN400262	8056138182370	



P N E U M A T I C



MADE
IN ITALY

DARK SIDE 99.9



EP 2.202.477 B1 | 100% CARBONIO

DARK SIDE



EP 2.202.477 B1 | 100% CARBONIO

- Testata "Vuoto"
 - Serbatoio cilindrico in fibra di carbonio ad alto modulo Pre-Peg TW-K03
 - Canna interna ø 13mm
 - Assetto perfettamente equilibrato
 - Linea di mira co-stampata nel fusto
 - Linea di tiro evidenziata per ottimizzare il sistema di puntamento
 - Kit Race di serie
 - Impugnatura in nylon caricato vetro
 - Regolatore di potenza incluso (85mm/99.9mm/115mm)
 - Sgancia sagola laterale "Dynamic Four"
 - Predisposizione per mulinello Salvimar Predathor 70 e Micro Predathor
 - Iniettore incluso
 - NUOVO ALLESTIMENTO: codolo con taglio a 45°
- Vacuum muzzle
 - Round carbon fiber Pre-Peg TW-K03
 - Internal barrel diameter ID 13mm
 - Perfect buoyancy
 - Line of sight imprinted in the barrel
 - Highlighted shot line, best pointing system
 - Kit Race included
 - Fiberglass reinforced nylon construction
 - High/Low power loader (85mm/99.9mm/115mm)
 - "Dynamic Four" Side Line Release
 - Suitable for "Side Friction" Predathor 70 and Micro Predathor
 - Pump included
 - NEW SET-UP: TAIL with 45° cut



POWER REGULATOR



KIT RACE PREDATHOR

SIZE	SHAFT	LENGHT	TAHIT. 17-4PH	SCREWED	PWR	COD.	EAN	€
55cm	7,0mm	512mm		✓		306055C	8057685557048	
65cm	7,0mm	662mm		✓		306065C	8058093684937	
75cm	7,0mm	870mm	✓		✓	306075C	8058093684944	
85cm	7,0mm	970mm	✓		✓	306085C	8057685557055	
99.9cm	7,5mm	1120mm	✓		✓	306099C	8058093681998	
115cm	7,5mm	1270mm	✓		✓	306115C	8057685557062	
130cm	7,5mm	1420mm	✓		✓	306130C	8056138184350	



MADE IN ITALY

PREDATHOR VUOTO



EP 2.202.477 B1



- Testata "Vuoto"
- Serbatoio cilindrico in alluminio
- Canna interna ø 13mm
- Impugnatura in nylon caricato vetro
- Regolatore di potenza incluso, 75cm, 85cm, 100cm, 115cm, 130cm
- Sgancia sagola laterale "Dynamic Four"
- Mulinello di serie Predathor reel 70 nelle lunghezze 85cm, 100cm, 115cm e 130cm
- Iniettore incluso
- NUOVO ALLESTIMENTO: codolo con taglio a 45°

- Vacuum muzzle
- Round alloy barrel
- Internal barrel diameter ID 13mm
- Fiberglass reinforced nylon construction
- High/Low power loader, 75cm, 85cm, 100cm, 115cm, 130cm
- Dynamic Four Side Line Release
- Predathor reel 70 standard 85cm 100cm 115cm & 130cm
- Pump included
- NEW SET-UP: TAIL with 45° cut



PREDATHOR REEL 70



MICRO PREDATHOR REEL
Per Predathor vuoto 85cm

SIZE	SHAFT	LENGHT	TAHIT.	17-4PH	SCREWED	PWR	REEL	COD.	EAN	€
40cm	7,0mm	350mm			✓			306040S	8057685557079	
55cm	7,0mm	512mm			✓			306055S	8057685557086	
65cm	7,0mm	662mm			✓			306065S	8057685557093	
75cm	7,0mm	870mm	✓			✓		306075V	8057685551152	
85cm	7,0mm	970mm	✓			✓	✓	306085V	8057685551176	
100cm	7,0mm	1120mm	✓			✓	✓	306100V	8057685551237	
115cm	7,5mm	1270mm	✓			✓	✓	306115V	8057685551312	
130cm	7,5mm	1420mm	✓			✓	✓	306130V	8057685551336	

MADE
IN ITALY

PREDATHOR KRYPSIS VUOTO



EP 2.202.477 B1

AIR TAHIT. 17-4PH



- Testata "Vuoto"
- Serbatoio cilindrico in alluminio
- Canna interna ø 13mm
- Impugnatura in nylon caricato vetro
- Regolatore di potenza incluso
- Sgancia sagola laterale "Dynamic Four"
- Iniettore incluso
- Asta a doppia aletta AIR TAHITIANA
- Mimetizzato in sublimazione permanente Krypsis Salvimar Pattern
- NUOVO ALLESTIMENTO: codolo con taglio a 45°
- Predisposizione per mulinello Predathor 70 e Micro Predathor

- Vacuum muzzle
- Round alloy barrel
- Internal barrel diameter ID 13mm
- Fiberglass reinforced nylon construction
- High/Low power loader
- Dynamic Four Side Line Release
- Pump included
- Double barb AIR TAHITIANA shaft
- Camouflaged using permanent sublimation technology Salvimar Krypsis Camouflage Pattern
- NEW SET-UP: TAIL with 45° cut
- Predisposition for Predathor 70 and Micro Predathor reel



SIZE	SHAFT	LENGHT	TAHIT. 17-4PH	PWR	COD.	EAN	€
75cm	7,0mm	870mm	APNE270087	✓	PNEKY075	8056138180888	
85cm	7,0mm	970mm	APNE270097	✓	PNEKY085	8056138180895	
100cm	7,0mm	1120mm	APNE270112	✓	PNEKY100	8056138180918	



MADE IN ITALY

PREDATHOR PLUS

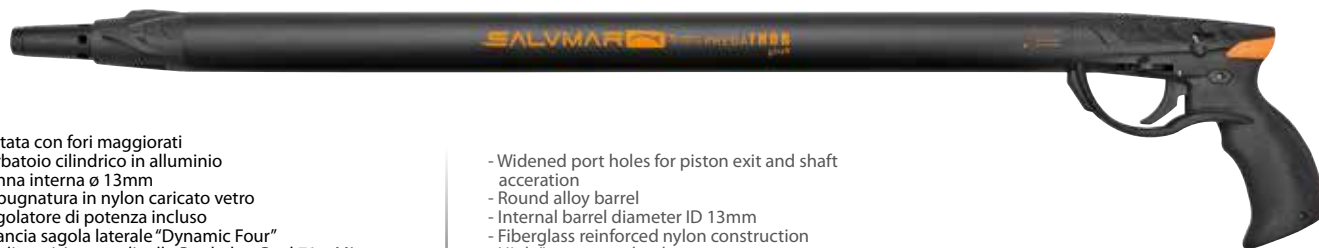

- Testata con fori maggiorati
- Serbatoio cilindrico in alluminio
- Canna interna ø 13mm
- Impugnatura in nylon caricato vetro
- Regolatore di potenza incluso
- Sgancia sagola laterale "Dynamic Four"
- Predisposizione mulinello Predathor Reel 70 e Micro Predathor reel
- Iniettore incluso
- NUOVO ALLESTIMENTO: codolo con taglio a 45° nelle misure 100 - 115 - 130

- Widened port holes for piston exit and shaft acceleration
- Round alloy barrel
- Internal barrel diameter ID 13mm
- Fiberglass reinforced nylon construction
- High/Low power loader
- Dynamic Four side line release
- Reel ready receiver for Side Predathor Reel 70 and Micro Predathor reel
- Pump included
- NEW SET-UP: TAIL with 45° cut for sized 100-115-130

SIZE	SHAFT	LENGHT	TAHIT. 17-4PH	SCREWED	PWR	REEL	COD.	EAN	€
55cm	8,0mm	500mm		✓	✓		306055P	8057685550940	
65cm	8,0mm	650mm		✓	✓		306065P	8057685550957	
75cm	8,0mm	750mm		✓	✓		306075P	8057685550964	
85cm	8,0mm	850mm		✓	✓		306085P	8057685551060	
100cm	7,5mm	1120mm	✓		✓		306100P	8057685551084	
115cm	7,5mm	1270mm	✓		✓		306115P	8057685551091	
130cm	7,5mm	1420mm	✓		✓		306130P	8057685551107	

PREDATHOR

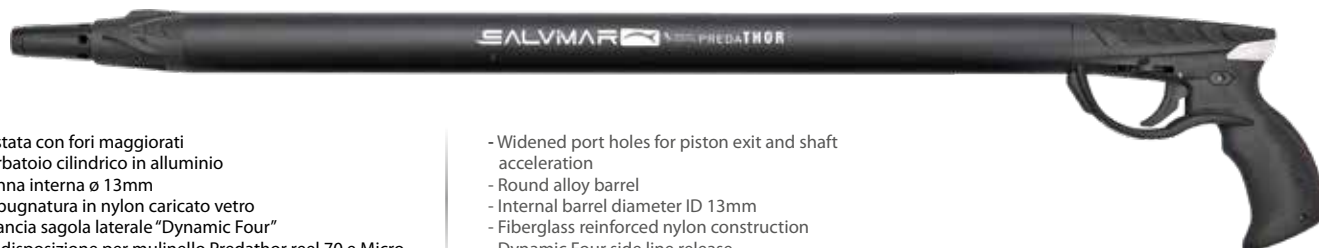

- Testata con fori maggiorati
- Serbatoio cilindrico in alluminio
- Canna interna ø 13mm
- Impugnatura in nylon caricato vetro
- Sgancia sagola laterale "Dynamic Four"
- Predisposizione per mulinello Predathor reel 70 e Micro Predathor reel
- Iniettore incluso

- Widened port holes for piston exit and shaft acceleration
- Round alloy barrel
- Internal barrel diameter ID 13mm
- Fiberglass reinforced nylon construction
- Dynamic Four side line release
- Reel ready receiver for Predathor reel 70 and Micro Predathor reel
- Pump included

SIZE	SHAFT	LENGHT	TAHIT. 17-4PH	SCREWED	PWR	REEL	COD.	EAN	€
40cm	8mm	350mm		✓			306040	8057685552197	
55cm	8mm	500mm		✓			306055	8057685550858	
65cm	8mm	650mm		✓			306065	8057685550872	
75cm	8mm	750mm		✓			306075	8057685550902	

PREDATHOR ROCK



- Testata con fori maggiorati
- Serbatoio cilindrico in alluminio
- Canna interna ø 13mm
- Impugnatura in nylon caricato vetro
- Sgancia sagola laterale "Dynamic Four"
- Predisposizione per mulinello Predathor reel 70 e Micro Predathor reel
- Iniettore non incluso

- Widened port holes for piston exit and shaft acceleration
- Round alloy barrel
- Internal barrel diameter ID 13mm
- Fiberglass reinforced nylon construction
- Dynamic Four side line release
- Reel ready receiver for Predathor reel 70 and Micro Predathor reel
- Not included pump

SIZE	SHAFT	LENGHT	TAHIT. 17-4PH	SCREWED	PWR	REEL	COD.	EAN	€
40cm		350mm		✓			306040R	8058093686771	
55cm		500mm		✓			306055R	8058093686788	
65cm		650mm		✓			306065R	8058093686795	

PREDATHOR REEL 70



- Mulinello verticale per pneumatico Predathor
- Componenti in Acciaio, Nylon e Delrin
- Frizione e manettino di riavvolgimento separati
- Staffa guida sagola
- Compatibile con tutti i Predathor Salvimar
- Componenti per l'assemblaggio di serie
- "Disegno e Concetto Tecnico sviluppato in Salvimar"

- Predathor Vertical Reel
- Stainless steel, Nylon and Delrin components
- Separate drag and handle for winding
- Line Guide
- Compatible with all Salvimar Predathor
- Standard supplied components for assembly
- "Design & Technical Concept made in Salvimar"

COLOR	CAPACITY	COD.	EAN	€
BLACK	70m x 1,5mm	301005/FP	8058093684326	
RED/BLACK	70m x 1,5mm	301005/FP/R	8058093688867	
LIME - BROWN	70m x 1,5mm	301005/FP/L	8056138181151	

NEW ARRIVAL



MICRO PREDATHOR REEL

- Mulinello verticale per pneumatico Predathor
- Componenti in Alluminio anodizzato nero, Nylon e Delrin
- Frizione e manettino di riavvolgimento separati
- Staffa guida sagola
- Compatibile con tutti i Predathor Salvimar
- Componenti per l'assemblaggio di serie
- "Disegno e Concetto Tecnico sviluppato in Salvimar"

- Predathor Vertical Reel
- Black anodized Aluminum, Nylon and Delrin components
- Separate drag and handle for winding
- Line Guide
- Compatible with all Salvimar Predathor
- Standard supplied components for assembly
- "Design & Technical Concept made in Salvimar"

STAFFA IN ALLUMINIO ANODIZZATO NERO

COLOR	CAPACITY	COD.	EAN	€
BLACK	50m x 1,2mm	301005/CP	8056138188471	

TESTATA VUOTO



EP 2.202.477 B1



- Testata sottovuoto in alluminio alleggerito
- Componenti: ogiva - guarnizione di tenuta corpo - boccola di ammortizzo
- Alta resistenza

- Vacuum muzzle in machined lightweight aluminum
- Includes three parts; Stopper with shock absorber, aluminum muzzle, aluminum muzzle adapter with shaft seal

SIZE	COD.	EAN	€
13	302000A	8055960727612	
11	302000B	8055960727629	
11 evolution	302000C	8057685550841	

SPARE PARTS



- Boccola di ammortizzo testata VUOTO



- VUOTO vacuum muzzle bushing

SHAFT	TANG/CODOLO	BARREL/CANNA	COD.	EAN	€
7,00mm	8,00mm	11,00mm	302001	8057685552203	

SHAFT	TANG/CODOLO	BARREL/CANNA	COD.	EAN	€
8,00mm	9,00mm	13,00mm	302001B	8055960727650	



- Guarnizione testata sottovuoto unica per aste ømm 6,5 / 7 / 7,5 / 8

- One vacuum Gasket for shaft omm 6,5 / 7 / 7,5 / 8

KIT	COD.	EAN	€
3 pieces	LFUCPNEUM24	8055960727636	

KIT RACE



- Pistone alleggerito ad alta scorrevolezza
- Grilletto sensitive
- Sgancia sagola e sicura acid gren

- Lightweight piston, low friction action
- Trigger sensitive
- Acid green construction, line release, trigger and safety

COLOR	COD.	EAN	€
ACID GREEN/BLACK	306000	8057685557147	

UTENSILE PREDATHOR

- Utensile per smontaggio valvola di ricarica Predathor

- Tool for dismantling the Predathor charging valve

COD.	EAN	€
AE123	8058093682919	

CARICHINO SCALETTA

- Scaletta per caricamento fucile pneumatico
- Costituito da 5 carichini in nylon caricato vetro 30% collegati tra loro con sagola da Ø 2mm
- Permette il caricamento agevole di pneumatici lunghi
- Adatto a tutti i modelli con asta Tahitiana o harpione

- Ladder for pneumatic speargun loading
- Consisting of five 30% glass-filled nylon loaders connected to each other with a Ø 2mm line
- Allows easy loading of long pneumatic spearguns
- Suitable for all models with Tahitian shaft or harpion

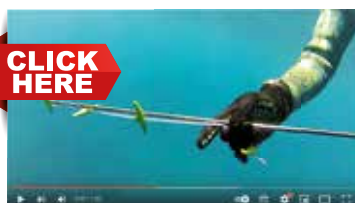

CLICK HERE



COD.	EAN	€
AE066	8056138181618	

MANOMETRO PREDATHOR PRO
PRESSURE GAUGE PREDATHOR PRO

- Manometro con valvola di ricarica integrata (Predathor)
- Permette di visualizzare la pressione durante la carica.

- Pressure gauge with integrated refill valve (Predathor)
- It allows to view the pressure during charging.

COD.	EAN	€
AE124/A	8058093687730	



CRESSI

MARES

SL: AE124/C



CYRANO/STEN: AE124/B



KIT: AE120

ADATTATORI INIETTORI

- Adattatori iniettori Cressi / Mares per valvola finale SALVIMAR

- Cressi / Mares injector adapters for SALVIMAR end valve

COD.		EAN	€
AE125	ADATTATORE PER INIETTORE CRESSI	8056138188907	
AE126	ADATTATORE PER INIETTORE MARES	8056138188914	

MANOMETRO PRO - PRESSURE GAUGE PRO

- Manometro con valvola di ricarica per fucile pneumatico
- Consente d'immettere aria nel pneumatico visualizzando la pressione interna
- Disponibile in versione Cyrano/Sten o SL

- Pressure gauge with refill valve for pneumatic gun
- Allows air to be injected into the pneumatic gun by displaying the internal pressure
- Available in Cyrano/Sten or SL version

	COD.	EAN	€
CYRANO/STEN	AE124/B	8058093689246	
SL	AE124/C	8058093689253	

MANOMETRO - PRESSURE GAUGE

- Manometro per fucili pneumatici
- Scala 0/40 bar

- Pressure gauge, pneumatic spearguns
- 0/40 bar

PRESSURE GAUGE	COD.	EAN	€
VINTAIR	AE122/A	8057685558489	
CYRANO/STEN	AE122/B	8057685558472	
SL	AE122/C	8057685558465	
PREDATHOR	AE122/D	8057685558458	

AIR PRESSURE - MEASURING KIT

AE120/A
VINTAIR AdaptorAE120/B
CYRANO/STEN AdaptorAE120/C
SL AdaptorAE120/D
PREDATHOR Adaptor

KIT	COD.	EAN	€
GAUGE + 4 ADAPTORS	AE120	8057685550735	

ADAPTORS	COD.	EAN	€
VINTAIR	AE120/A	8057685551596	
CYRANO/STEN	AE120/B	8057685551602	
SL	AE120/C	8057685551619	
PREDATHOR	AE120/D	8057685554177	

GREEN 32 PNEUMATIC GUN OIL

- Formula extra-fluid
- Basso indice di viscosità
- Prestazioni elevate in ogni condizione e temperatura
- Proprietà antiusura e antiossidanti
- 100ml

- Formulated specifically for pneumatics
- Low viscosity Index
- High performance characteristics unaffected by temperature changes
- Anti-wear and corrosion protection
- 100ml bottle

KIT	COD.	EAN	€
kit 4 pieces	306001	8057685558502	

OIL QUANTITY OREDATHOR

MODEL	ml
40cm	10
55cm	15
65cm	18
75cm	21
85cm	25
100cm	28
115cm	33
130cm	37



PREDATHOR VUOTO - PREDATHOR PLUS - PREDATHOR - DARK SIDE - ROCK

DESCRIPTION	LEGEND	COD.	EAN	€
KIT O-RING VINTAIR E VINTAIR PLUS/PREDATHOR KIT O-RING VINTAIR AND VINTAIR PLUS/PREDATHOR	15	LFUCPNEUMKIT 01	8055960725854	
KIT DENTE DI SGANCIO VINTAIR / PREDATHOR	6	LFUCPNEUMKIT03	8055960725915	
MOLLETTA ESTRAZIONE TAPPO PREDATHOR AISI 302 2MM CAP CLIP PREDATHOR	1	LFUCPR020	8057685556867	
TAPPO COPRIVALVOLA PREDATHOR BIANCO VALVE CAP PREDATHOR WHITE	2	LFUCPR003A	8057685556614	
TAPPO COPRIVALVOLA PREDATHOR VERDE VALVE CAP PREDATHOR ACID GREEN	2	LFUCPR003B	8057685556621	
TAPPO COPRIVALVOLA PREDATHOR ARANCIONE VALVE CAP PREDATHOR ORANGE	2	LFUCPR003C	8057685556638	
VALVOLA RICARICA PREDATHOR REFILL VALVE PREDATHOR	3	LFUCPR004	8057685556645	
SICURA PREDATHOR SAFE PREDATHOR	5	LFUCPR005	8057685556652	
KIT GRILLETTO PREDATHOR TRIGGER MECHANISM KIT	7 + 8	LFUCPR008	8057685556683	
IMPUGNATURA PREDATHOR NERA CON REGOLATORE HANDLE PREDATHOR PLUS BLACK WITH PWR	9A	LFUCPR001	8057685556591	
IMPUGNATURA PREDATHOR NERA (SENZA REGOLATORE) HANDLE PREDATHOR BLACK (WITHOUT POWER REGULATOR)	9B	LFUCPR001B	8057685556607	
KIT SGANGIA SAGOLA PREDATHOR LINE RELEASE KIT	10	LFUCPR009	8057685556690	
PISTONE VINTAIR - PREDATHOR VINTAIR PISTON - PREDATHOR	13	LFUCPNEUMKIT 101	8055960725861	
KIT BOLCCHETTO REGOLAZIONE COMPLETA DI ASTINA POWER ADJUSTMENT BLOCK KIT	14	LFUCPRKIT03	8057685556898	
OGIVA PREDATHOR OGIVE PREDATHOR	19	LFUCPRKIT01	8057685556874	
TESTATA PREDATHOR COMPLETA COMPLETE MUZZLE KIT	20	LFUCPRKIT02	8057685556881	
CANNA PREDATHOR ALLESTITA 40 RIFLE PREDATHOR 40	21	LFUCPR010A	8057685556706	
CANNA PREDATHOR ALLESTITA 55 RIFLE PREDATHOR 55	21	LFUCPR010B	8057685556713	
CANNA PREDATHOR ALLESTITA 65 RIFLE PREDATHOR 65	21	LFUCPR010C	8057685556720	
CANNA PREDATHOR ALLESTITA 75 RIFLE PREDATHOR 75	21	LFUCPR010D	8057685556737	
CANNA PREDATHOR ALLESTITA 85 RIFLE PREDATHOR 85	21	LFUCPR010E	8057685556744	
CANNA PREDATHOR ALLESTITA 100 RIFLE PREDATHOR 100	21	LFUCPR010F	8057685556751	
CANNA PREDATHOR ALLESTITA 115 RIFLE PREDATHOR 115	21	LFUCPR010G	8057685556768	
CANNA PREDATHOR ALLESTITA 130 RIFLE PREDATHOR 130	21	LFUCPR010H	8057685556775	
SERBATOIO PREDATHOR 40 BARREL FOR PREDATHOR 40	22	LFUCPR011A	8057685556782	
SERBATOIO PREDATHOR 55 BARREL FOR PREDATHOR 55	22	LFUCPR011B	8057685556799	
SERBATOIO PREDATHOR 65 BARREL FOR PREDATHOR 65	22	LFUCPR011C	8057685556805	
SERBATOIO PREDATHOR 75 BARREL FOR PREDATHOR 75	22	LFUCPR011D	8057685556812	
SERBATOIO PREDATHOR 85 BARREL FOR PREDATHOR 85	22	LFUCPR011E	8057685556829	
SERBATOIO PREDATHOR 100 BARREL FOR PREDATHOR 100	22	LFUCPR011F	8057685556836	
SERBATOIO PREDATHOR 115 BARREL FOR PREDATHOR 115	22	LFUCPR011G	8057685556843	
SERBATOIO PREDATHOR 130 BARREL FOR PREDATHOR 130	22	LFUCPR011H	8057685556850	
INIETTORE VINTAIR - PREDATHOR PUMP VINTAIR - PREDATHOR	23	LFUCPNEUM100	8055960725878	
KIT REVISIONE PREDATHOR SERVICE KIT PREDATHOR		302051A	8057685556546	
KIT REVISIONE PREDATHOR PLUS SERVICE KIT PREDATHOR PLUS		302051B	8057685556553	
KIT REVISIONE PREDATHOR VUOTO SERVICE KIT PREDATHOR VUOTO		302051C	8057685556560	

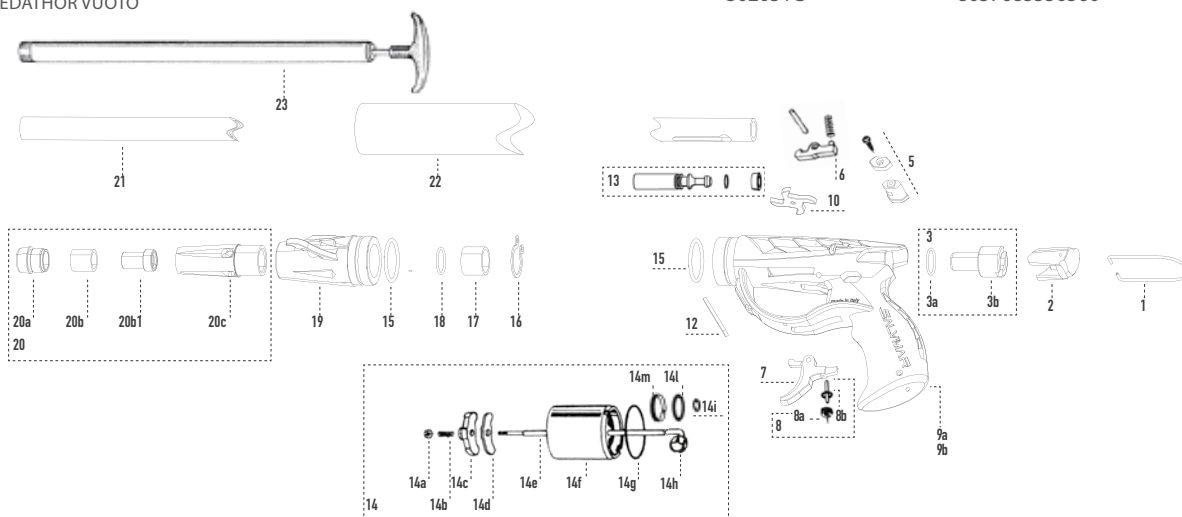

STEN SERIES

DESCRIPTION	COD.	EAN	€
STEN PISTONE / PISTON	302040A	8055960727513	
STEN KIT BOCCOLA DI AMMORTIZZO STEN BUSHING DAMPING KIT	LFUCPNEUMKIT02	8055960725885	
STEN VALVOLA / VALVE	302040D	8055960727537	

CYRANO SERIES

DESCRIPTION	COD.	EAN	€
CYRANO PISTONE / PISTON	302042A	8055960727544	
CYRANO KIT TESTATA COMPLETO CYRANO COMPLETE MUZZLE KIT	302042B	8055960727551	
CYRANO KIT BOCCOLA DI AMMORTIZZO CYRANO BUSHING DAMPING KIT	302042C	8055960727568	
CYRANO VALVOLA / VALVE	302042D	8055960727575	

SL SERIES

DESCRIPTION	COD.	EAN	€
SL PISTONE / PISTON	302044A	8055960727582	
SL VALVOLA / VALVE	302044D	8055960727605	



W E T S U I T S



FABRIC WETSUITS

**3D KRYPSIS 101 SPANDEX**

Innovativo 3D Camo Krypssis 101 design in tessuto **Spandex** super elastico

Ultimate 3D Krypssis 101 Camo design in Super -Elastic **Spandex**

**SCALES EFFECT ON SPANDEX**

Innovativo effetto "Shining Scales" realizzato su tessuto super elastico **Spandex**

Ultimate "Shining Scales" effect inserted on Super Elastic **Spandex**

**3D KRYPSIS OCEAN 101 SPANDEX**

Innovativo 3D Camo Krypssis Ocean design in tessuto **Spandex** super elastico

Ultimate 3D Krypssis Ocean Camo design in Super -Elastic **Spandex**

**3D N.A.T. 101 SPANDEX**

Innovativo 3D Camo N.A.T. 101 design in tessuto **Spandex** super elastico

Ultimate 3D N.A.T. 101 Camo design in Super -Elastic **Spandex**

**3D KROMICK SPANDEX**

Innovativo 3D Camo Kromick design in tessuto **Spandex** super elastico

Ultimate 3D Kromick Camo design in Super -Elastic **Spandex**

**3D KRYPTONITE SPANDEX**

Innovativo 3D Camo Kryptonite design in tessuto **Spandex** super elastico

Ultimate 3D Kryptonite Camo design in Super -Elastic **Spandex**

**SUPER STRETCH SPANDEX**

Innovativo 3D Camo design in tessuto **Spandex** super elastico

Ultimate 3D Camo design in Super -Elastic **Spandex**

**SCALES EFFECT ON SPANDEX**

Innovativo effetto "Shining Scales" realizzato su tessuto super elastico **Spandex**

Ultimate "Shining Scales" effect inserted on Super Elastic **Spandex**

**STRETCH NYLON DOUBLE LINING**

Tessuto Stretch Nylon doppia fodera

Stretch nylon fabric -double lining

**SUPER STRETCH SPANDEX**

Innovativo tessuto **Spandex** in Super-Elastico con memoria attiva

Ultimate Super-Elastic **Spandex** fabric with active memory

TECHNICAL DETAIL WETSUITS

**CHEST - BREAST PROTECTION**

Rinforzo sternale in **A.R.I.S** (Abrasion Resistant Ink System) esterno con neoprene padded all'interno, per un efficace protezione

Chest protection in **A.R.I.S** (Abrasion Resistant Ink System) outside and padded neoprene inside, excellent protection in any gun loading condition.

**KNEE PROTECTION**

Rinforzo alle ginocchia in **A.R.I.S**

Knee protection **A.R.I.S**

**CSRSS CAMO SCALES ROUND SEAL SYSTEM**

Anelli di chiusura in Camo Scales/Open Cell per tenuta polsi, caviglie, giro-vita e giro-faccia

Special Camo Scales/Open Cell sealing rings on wrists, ankles, waist and round face

**GBS**

Cucitura interna a doppio ago non passante con incollaggio centrale bi-componente, tenuta stagna garantita

Two-component gluing and blind stitching system for a perfect waterproof sealing

**ADJUSTABLE BUTTON**

Chiusura sotto-cavallo con singolo bottone

Single plastic snap buttons fastening

**ADJUSTABLE BUTTONS**

Chiusura sotto-cavallo con doppio bottone

Double plastic snap buttons fastening

**ERGO FIT**

Taglio-vestizione anatomica a compressione orizzontale

Anatomic fit with horizontal way compression

KRYPSIS 101 SCALES



- Muta due pezzi con fodera esterna in tessuto Spandex 3D Krypsis Mimetico, tecnologia di sublimazione con applicazione di squame trasparenti (Scales Effect) per riprodurre l'ambiente circostante
 - Taglio anatomico con compressione orizzontale/graduale per facilitare i movimenti e la respirazione, elasticità e comfort assoluto in qualsiasi condizione
 - Doppia cucitura interna non passante con sistema GBS e incollaggio centrale bi-componente
 - Protezione al torace e alle Ginocchia con il nuovo sistema A.R.I.S (Abrasion Resistant Ink System) massima protezione e elasticità nei punti di maggior contatto
 - Rifiniture di tenuta in CSRSS (Camo Scales Round Seal System) su polsi, caviglie, viso e giro-vita per bilanciare correttamente la tenuta su tutte l'estremità della muta
 - Coda di castoro con doppio bottone di chiusura
- Two-piece wetsuit with outer lining in Spandex 3D Krypsis Camouflage fabric, sublimation technology with application of transparent scales (Scales Effect) to reproduce the surrounding environment
 - Anatomical cut with horizontal/gradual compression for ease of movement and breathing, elasticity and absolute comfort in all conditions
 - Double non-pass-through inner stitching with GBS system and bi-component central bonding
 - Chest and knee protection with the new A.R.I.S (Abrasion Resistant Ink System), maximum protection and elasticity at the points of greatest contact
 - Seal finishes in CSRSS (Camo Scales Round Seal System) on wrists, ankles, face and waist to balance the seal correctly on all ends of the wetsuit
 - Beavertail seal with double button closure



SCALES EFFECT ON SPANDEX



CHEST BREAST PROTECTION



KNEE PROTECTION



CSRSS CAMO SCALES ROUND SEAL SYSTEM



GBS



ADJUSTABLE BUTTONS



ERGO FIT

SIZE	THICKNESS	COD.	EAN	€
S	5,0mm	MUT002020	8056138184664	
M	5,0mm	MUT002030	8056138184671	
L	5,0mm	MUT002040	8056138184688	
XL	5,0mm	MUT002050	8056138184695	
XXI	5,0mm	MUT002060	8056138184701	

KRYPSIS 101



- Materiale esterno: fodera ultra - elastica Salvimar Camo
- Materiale interno: neoprene SH-L FOAM medium density a cellula aperta
- Pantalone a spessore differenziato, per facilitare la respirazione
- Protezioni e rinforzi su torace e ginocchia
- Doppia cucitura GBS ad incrocio per una massima resistenza e tenuta
- Chiusura con coda di castoreo a doppio bottone Salvimar
- Bordi di finitura in CRSS (Camo Round Seal System) su polsi, caviglie, ovale volto e bordo vita per migliorare la resistenza nel tempo

- Outer material: ultra elastic Salvimar Camo lining
- Inner material: SH-L FOAM medium density open cell neoprene
- Trousers with differentiated thickness to facilitate breathing
- 5 Guards and reinforcement on torso and knees
- Double GBS cross seam for maximum strength and seal
- Beavertail seal with Salvimar double button
- CRSS (Camo Round Seal System) external trim on wrists, ankles, face and waist to improve durability over time

**KRYPSIS 101 - 3,5mm**

SIZE	THICKNESS	COD.	EAN	€
S	3,5mm	101350A	8058093687846	
M	3,5mm	101350B	8058093687853	
L	3,5mm	101350C	8058093687938	
XL	3,5mm	101350D	8058093687945	
XXL	3,5mm	101350E	8058093687952	

KRYPSIS 101 JACKET 3,5mm

SIZE	THICKNESS	COD.	EAN	€
S	3,5mm	101350A/G	8058093687907	
M	3,5mm	101350B/G	8058093687914	
L	3,5mm	101350C/G	8058093687969	
XL	3,5mm	101350D/G	8058093687976	
XXL	3,5mm	101350E/G	8058093687983	

KRYPSIS 101 TROUSERS 3,5mm

SIZE	THICKNESS	COD.	EAN	€
S	3,5mm	101350A/P	8058093687891	
M	3,5mm	101350B/P	8058093687921	
L	3,5mm	101350C/P	8058093687990	
XL	3,5mm	101350A/P	8058093688003	
XXL	3,5mm	101350E/P	8058093688010	

KRYPSIS 101 - 5,5mm

SIZE	THICKNESS	COD.	EAN	€
S	5,5mm	101550A	8058093687860	
M	5,5mm	101550B	8058093687877	
L	5,5mm	101550C	8058093688027	
XL	5,5mm	101550D	8058093688034	
XXL	5,5mm	101550E	8058093688041	

SIZE	THICKNESS	COD.	EAN	€
S	5,5mm	101550A/G	8058093688089	
M	5,5mm	101550B/G	8058093688096	
L	5,5mm	101550C/G	8058093688102	
XL	5,5mm	101550D/G	8058093688119	
XXL	5,5mm	101550E/G	8058093688126	

KRYPSIS 101 TROUSERS 5,5mm

SIZE	THICKNESS	COD.	EAN	€
S	5,5mm	101550A/P	8058093688133	
M	5,5mm	101550B/P	8058093688140	
L	5,5mm	101550C/P	8058093688157	
XL	5,5mm	101550D/P	8058093688164	
XXL	5,5mm	101550E/P	8058093688171	

KRYPSIS 101 - 7,0mm

SIZE	THICKNESS	COD.	EAN	€
S	7,0mm	101700A	8058093688287	
M	7,0mm	101700B	8058093687884	
L	7,0mm	101700C	8058093688058	
XL	7,0mm	101700D	8058093688065	
XXL	7,0mm	101700E	8058093688072	

KRYPSIS 101 JACKET 7,0mm

SIZE	THICKNESS	COD.	EAN	€
S	7,0mm	101700A/G	8058093688188	
M	7,0mm	101700B/G	8058093688195	
L	7,0mm	101700C/G	8058093688201	
XL	7,0mm	101700D/G	8058093688218	
XXL	7,0mm	101700E/G	8058093688225	

KRYPSIS 101 TROUSERS 7,0mm

SIZE	THICKNESS	COD.	EAN	€
S	7,0mm	101700A/P	8058093688232	
M	7,0mm	101700B/P	8058093688249	
L	7,0mm	101700C/P	8058093688256	
XL	7,0mm	101700D/P	8058093688270	
XXL	7,0mm	101700E/P	8058093688263	

- Muta due pezzi, giacca con cappuccio e pantalone a vita alta
Acquistabili anche separatamente

- 2-piece wetsuit with hooded jacket and high waisted pants
Also purchasable separately



- Muta due pezzi, giacca con cappuccio e pantalone a vita alta
 - Neoprene JAKO
 - Materiale esterno: fodera ultra - elastica SPANDEX Salvimar Camo
 - Materiale interno: neoprene Q-FOAM a cellula aperta
 - Fodera ultra elastica + Neoprene Q-FOAM = Confort e vestibilità eccellenti
 - Protezioni e rinforzi su torace e ginocchia
 - Doppia cucitura GBS ad incrocio per una massima resistenza e tenuta
 - Chiusura con coda di castoro a doppio bottone Salvimar
 - Bordi esterni in CRSS (Camo Round Seal System) su polsi, caviglie, ovale volto e bordo vita
 - Pantalone a spessore differenziato
- Two-piece wetsuit, jacket with hood and high-waisted trousers
 - JAKO neoprene
 - Exterior material: SPANDEX ultra - elastic Salvimar Camo
 - Ultra elastic lining + Neoprene Q-FOAM = Excellent comfort and easy wearability
 - Interior material: Q-FOAM open cell neoprene
 - Guards and reinforcement on torso and knees
 - Double GBS cross seam for maximum strength and seal
 - Beavertail seal with Salvimar double \ buttons
 - CRSS (Camo Round Seal System) external trim on wrists, ankles, face and waist
 - Trousers with differentiated thickness



3D KRYPISIS OCEAN 101 SPANDEX

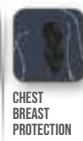

CHEST BREAST PROTECTION



KNEE PROTECTION



CSRSS CAMO SCALES ROUND SEAL SYSTEM



GBS



ADJUSTABLE BUTTONS



ERGO FIT

SIZE	THICKNESS	COD.	EAN	€
S	1,5mm	MUT006020	8056138187290	
M	1,5mm	MUT006030	8056138187306	
L	1,5mm	MUT006040	8056138187313	
XL	1,5mm	MUT006050	8056138187320	
XXL	1,5mm	MUT006060	8056138187337	

SIZE	THICKNESS	COD.	EAN	€
S	3,0mm	MUT006120	8056138187344	
M	3,0mm	MUT006130	8056138187351	
L	3,0mm	MUT006140	8056138187368	
XL	3,0mm	MUT006150	8056138187375	
XXL	3,0mm	MUT006160	8056138187382	



N.A.T. 101



- Muta due pezzi
- Materiale esterno: Lycra Spandex
- Materiale interno: neoprene spaccato open cell "Q - FOAM"
- Texture fodera: Salvimar N.A.T Camo
- Rinforzi su sterno e ginocchia
- Cuciture esterne
- Chiusura con bottone regolabile
- Finiture caviglie e polsi in **OVERLOCK**

- Two-piece wetsuit
- External: Lycra Spandex
- Internal: "Q - FOAM" Open cell
- Lining texture: Salvimar N.A.T Camo
- Reinforcements in the chest and knees
- External stitching
- Closure: Beavertail adjustable clip
- **OVERLOCK** finishes on wrists and ankles



3D
N.A.T. 101
SPANDEX



CHEST
BREAST
PROTECTION



KNEE
PROTECTION



CSRSS
CAMO SCALES
ROUND SEAL
SYSTEM



GBS



ADJUSTABLE
BUTTON



ERGO FIT

SIZE	THICKNESS	COD.	EAN	€
S	3,5mm	101101A	8056138180284	
M	3,5mm	101101B	8056138180291	
L	3,5mm	101101C	8056138180307	
XL	3,5mm	101101D	8056138180314	
XXL	3,5mm	101101E	8056138180321	

SIZE	THICKNESS	COD.	EAN	€
S	5,5mm	101102A	8056138180338	
M	5,5mm	101102B	8056138180345	
L	5,5mm	101102C	8056138180352	
XL	5,5mm	101102D	8056138180369	
XXL	5,5mm	101102E	8056138180376	

SIZE	THICKNESS	COD.	EAN	€
S	7,0mm	101103A	8056138180383	
M	7,0mm	101103B	8056138180390	
L	7,0mm	101103C	8056138180406	
XL	7,0mm	101103D	8056138180413	
XXL	7,0mm	101103E	8056138180420	

KRYPTONITE



- Muta due pezzi, giacca con cappuccio e pantalone a vita alta
- Materiale esterno: fodera ultra - elastica SPANDEX Salvimar Camo
- Materiale interno: neoprene Q-FOAM a cellula aperta
- Fodera ultra elastica + Neoprene Q-FOAM = Confort e vestibilità eccellenti
- Protezioni e rinforzi su torace e ginocchia
- Doppia cucitura GBS ad incrocio per una massima resistenza e tenuta
- Chiusura con coda di castoro a doppio bottone Salvimar
- Bordi esterni in CRSS (Camo Round Seal System) su polsi, caviglie, ovale volto e bordo vita
- Pantalone a spessore differenziato

- Two-piece wetsuit, jacket with hood and high-waisted trousers
- Exterior material: ultra - SPANDEX elastic Salvimar Camo
- Ultra elastic lining + Neoprene Q-FOAM = Excellent comfort and easy wearability
- Interior material: Q-FOAM open cell neoprene
- Guards and reinforcement on torso and knees
- Double GBS cross seam for maximum strength and seal
- Beavertail seal with Salvimar double \ buttons
- CRSS (Camo Round Seal System) external trim on wrists, ankles, face and waist
- Trousers with differentiated thickness

DEEPER KRYPTONITE _ PAG. 99

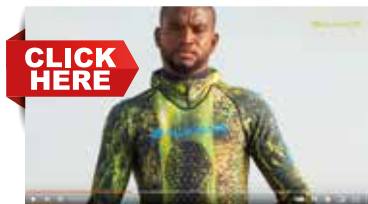
3D
KRYPTONITE
SPANDEXCHEST
BREAST
PROTECTIONKNEE
PROTECTIONCRSS
CAMO SCALES
ROUND SEAL
SYSTEM

GBS

ADJUSTABLE
BUTTONS

ERGO FIT

SIZE	THICKNESS	COD.	EAN	€
S	1,5mm	100460A	8058093685897	
M	1,5mm	100460B	8058093685903	
L	1,5mm	100460C	8058093685910	
XL	1,5mm	100460D	8058093685927	
XXL	1,5mm	100460E	8058093685934	



SIZE	THICKNESS	COD.	EAN	€
S	3,0mm	100480A	8058093686009	
M	3,0mm	100480B	8058093686016	
L	3,0mm	100480C	8058093686023	
XL	3,0mm	100480D	8058093686030	
XXL	3,0mm	100480E	8058093686047	



WET DROP CELL



- Muta due pezzi
- Materiale esterno: fodera Nylon
- Materiale interno: neoprene spaccato open cell "Q - FOAM"
- Rinforzi su sterno e ginocchia
- Cuciture esterne
- Chiusura con bottone regolabile
- Finiture caviglie e polsi in **OVERLOCK**

- Two-piece
- External: Nylon lined
- Internal: "Q - FOAM" Open cell
- Reinforcements in the chest and knees
- External stitching
- Closure: Beavertail adjustable clip
- **OVERLOCK** finishes on wrists and ankles



DROP BACK PACK _ PAG. 69



SIZE	THICKNESS	COD.	EAN	€
S	3,5mm	100626W	8055960722716	
M	3,5mm	100628W	8055960722723	
L	3,5mm	100630W	8055960722730	
XL	3,5mm	100632W	8055960722747	
XXL	3,5mm	100634W	8055960722990	

SIZE	THICKNESS	COD.	EAN	€
S	5,5mm	100636W	8055960726479	
M	5,5mm	100638W	8055960726486	
L	5,5mm	100640W	8055960726493	
XL	5,5mm	100642W	8055960726509	
XXL	5,5mm	100644W	8055960726516	

SIZE	THICKNESS	COD.	EAN	€
S	7,0mm	100646W	8055960726523	
M	7,0mm	100648W	8055960726530	
L	7,0mm	100650W	8055960726547	
XL	7,0mm	100652W	8055960726554	
XXL	7,0mm	100654W	8055960726561	

COMFORTY

NEW
ARRIVAL

- Muta Apnea due pezzi con neoprene CR doppia fodera Nylon stretch
- Vestizione agevolata grazie alla fodera interna, massimo comfort durante l'immersione
- Taglio anatomico con compressione orizzontale/graduale per facilitare i movimenti e la respirazione, elasticità e comfort assoluto in qualsiasi condizione
- Doppia cucitura interna/esterna non passante con sistema GBS e incollaggio centrale bi-componente
- A.R.I.S (Abrasion Resistant Ink System) al centro del torace e alle ginocchia per aumentare la protezione nei punti di maggior contatto
- Rifinitura Overlock su polsi, caviglie, giro vita e giro faccia per una rapida vestizione in tutte le condizioni
- Coda di Castoro con singolo bottone di chiusura SALVIMAR a sgancio rapido
- Two pieces free diving suit with CR neoprene and double lines stretch nylon
- Easy dressing thanks to inner stretch nylon, excellent comfort during dive
- Anatomic fit with horizontal/gradual compression way for easy breath and free movements, Absolute elasticity and comfort in any condition
- Inner/outer double blind stitching with GBS system and two-components glue application A.R.I.S (Abrasion Resistant Ink System) placed in the middle of the breast and on both knees for increase the protection on the points of main contact
- Overlock finishing on wrists, ankles, waist and round face for a quick dressing in any condition
- Beaver Tail with single Salvimar quick release bottom fastening

STRETCH
NYLON
DOUBLE
LININGCHEST
BREAST
PROTECTIONKNEE
PROTECTION

GBS

ADJUSTABLE
BUTTON

ERGO FIT

SIZE	THICKNESS	COD.	EAN	€
S	3,0mm	MUT004020	8056138185456	
M	3,0mm	MUT004030	8056138185463	
L	3,0mm	MUT004040	8056138185470	
XL	3,0mm	MUT004050	8056138185487	
XXL	3,0mm	MUT004060	8056138185494	

SIZE	THICKNESS	COD.	EAN	€
S	5,0mm	MUT004120	8056138185500	
M	5,0mm	MUT004130	8056138185517	
L	5,0mm	MUT004140	8056138185524	
XL	5,0mm	MUT004150	8056138185531	
XXL	5,0mm	MUT004160	8056138185548	

ABYSS RASH GUARD



- Rash Guard due pezzi con cappuccio per acque temperate
- Materiale: super elastico 230 gr
- Texture fodera: Salvimar Camo
- Chiusura con bottone regolabile
- Cuciture Fletlock
- Robusta e facile da indossare
- Protezione UV e da animali urticanti
- Supporto sternale
- Sottopiede di fissaggio

- Two-piece Rash Guard with hood for temperate waters
- Two-piece with hood Rash Guard
- External: super elastic 230 gr
- Pattern: Salvimar Camo
- Closure: Beavertail adjustable clip
- Stitching: Flatlock
- Wear and tear resistant and easy to wear
- UV protection and protection against stinging animals
- Chest support
- Fixing insole



SIZE	THICKNESS	COD.	EAN	€
S	100500A	8057685558991	8055960726523	
M	100500B	8057685559004	8055960726530	
L	100500C	8057685559011	8055960726547	
XL	100500D	8057685559028	8055960726554	
XXL	100500E	8057685559035	8055960726561	

SCALES LADY

NEW
ARRIVAL

- Muta Apnea due pezzi con fodera esterna in tessuto Spandex Mimetico, tecnologia di sublimazione e applicazione di squame trasparenti per riprodurre l'ambiente circostante
- Taglio anatomico con compressione orizzontale/graduale per facilitare i movimenti e la respirazione, elasticità e comfort assoluto in qualsiasi condizione
- Protezione al torace e alle Ginocchia con il nuovo sistema A.R.I.S (Abrasion Resistant Ink System) massima protezione e elasticità nei punti di maggior contatto
- Rifiniture di tenuta in CSRSS (Camo Scales Round Seal System) su polsi, caviglie, viso e giro-vita per bilanciare correttamente la tenuta su tutte l'estremità
- Coda di castoreo con singolo bottone di chiusura
- Two-piece wetsuit with outer Spandex fabric lining Camouflage, sublimation technology and application of transparent scales to reproduce the surrounding environment
- Anatomic fit with horizontal/gradual compression way for easy breath and free movements, Absolute elasticity and comfort in any condition
- Chest and knee protection with the new A.R.I.S (Abrasion Resistant Ink System) maximum protection and elasticity at the points of greatest contact
- Sealing seams in CSRSS (Camo Scales Round Seal System) on wrists, ankles, face and waist to balance the seal correctly on all ends of the suit
- Beaver Tail with single plastic snap button

SCALES
EFFECT ON
SPANDEXCHEST
BREAST
PROTECTIONKNEE
PROTECTIONCSRSS
CAMO SCALES
ROUND SEAL
SYSTEM

GBS

ADJUSTABLE
BUTTON

ERGO FIT

SIZE	THICKNESS	COD.	EAN	€
XS	5,0mm	MUT003010	8056138184749	
S	5,0mm	MUT003010	8056138184725	
M	5,0mm	MUT003020	8056138184718	
L	5,0mm	MUT003030	8056138184732	
XL	5,0mm	MUT003040	8056138184756	
XXL	5,0mm	MUT003050	8056138184763	

SEA WALKER LADY



- Muta spearfishing Sea Walker versione donna realizzata appositamente per le esigenze specifiche richieste nello spear fishing femminile
- Materiale esterno: fodera ultra - elastica SPANDEX Salvimar Camo
- Materiale interno: neoprene Q-FOAM a cellula aperta
- Fodera ultra elastica + Neoprene Q-FOAM = Confort e vestibilità eccellenti
- Protezioni e rinforzi su torace e ginocchia
- Doppia cucitura GBS ad incrocio per una massima resistenza e tenuta
- Chiusura con coda di castoreo
- Bordi esterni in CRSS (Camo Round Seal System) su polsi, caviglie, ovale volto e bordo vita
- Two pieces for spearfishing specifically designed for women comfort during apnea
- Exterior material: ultra - SPANDEX elastic Salvimar Camo
- Ultra elastic lining + Neoprene Q-FOAM = Excellent comfort and easy wearability
- Interior material: Q-FOAM open cell neoprene
- Guards and reinforcement on torso and knees
- Double GBS cross seam for maximum strength and seal
- Beavertail seal
- CRSS (Camo Round Seal System) external trim on wrists, ankles, face and waist



SUPER STRETCH SPANDEX



CHEST BREAST PROTECTION



KNEE PROTECTION



CRSS CAMO SCALES ROUND SEAL SYSTEM



GBS



ADJUSTABLE BUTTON



ERGO FIT

AVAILABLE 2024

NEW ARRIVAL	SIZE	THICKNESS	COD.	EAN	€
		XS	1,5mm	100710A	8056138187184
	S	1,5mm	100710B	8056138187191	
	M	1,5mm	100710C	8056138187207	
	L	1,5mm	100710D	8056138187214	
	XL	1,5mm	100710E	8056138187221	
	XXL	1,5mm	100710F	8056138187238	



SIZE	THICKNESS	COD.	EAN	€
XS	3,5mm	100711A	8058093683350	
S	3,5mm	100711B	8058093683367	
M	3,5mm	100711C	8058093683374	
L	3,5mm	100711D	8058093683381	
XL	3,5mm	100711E	8058093683398	
XXL	3,5mm	100711F	8056138182684	



SIZE	THICKNESS	COD.	EAN	€
XS	5,5mm	100712A	8058093683404	
S	5,5mm	100712B	8058093683411	
M	5,5mm	100712C	8058093683428	
L	5,5mm	100712D	8058093683435	
XL	5,5mm	100712E	8058093683442	
XXL	5,5mm	100712F	8056138182691	

SEA WALKER BLACK LADY

NEW
ARRIVAL

- Muta due pezzi realizzata in tessuto super elastico Spandex unito a neoprene Q Foam a cellule aperte con eccellente memoria elastica
- Taglio anatomico con compressione orizzontale/graduale per facilitare i movimenti e la respirazione, elasticità e comfort assoluto in qualsiasi condizione
- A.R.I.S (Abrasion Resistant Ink System) al centro del torace e alle ginocchia per aumentare la protezione nei punti di maggior contatto
- Anelli di tenuta in neoprene Black Spandex/ Open Cell su tutte l'estremità quali esterno viso, polsi, caviglie e giro-vita
- Coda di Castoro con singolo bottone di chiusura SALVIMAR a sgancio rapido
- Two pieces suit made in Super-Elastic Spandex fabric laminated on Q- Foam open cell neoprene with excellent memory foam
- Anatomic fit with horizontal/gradual compression way for easy breath and free movement, absolute elasticity and comfort in any condition
- A.R.I.S (Abrasion Resistant Ink System) placed in the middle of the breast and on both knees for increase the protection on the points of main contact
- Black Spandex/ Open Cell rings placed on every end of the body like round face, wrists, ankles and waist
- Beaver Tail with single Salvimar quick release bottom fastening

SUPER
STRETCH
SPANDEXCHEST
BREAST
PROTECTIONKNEE
PROTECTIONCSRSS
CAMO SCALES
ROUND SEAL
SYSTEM

GBS

ADJUSTABLE
BUTTON

ERGO FIT

SIZE	THICKNESS	COD.	EAN	€
XS	3,5mm	MUT005010	8056138185616	
S	3,5mm	MUT005020	8056138185555	
M	3,5mm	MUT005030	8056138185562	
L	3,5mm	MUT005040	8056138185579	
XL	3,5mm	MUT005050	8056138185586	
XXL	3,5mm	MUT005060	8056138185593	

SIZE	THICKNESS	COD.	EAN	€
XS	5,0mm	MUT005110	8056138185623	
S	5,0mm	MUT005120	8056138185609	
M	5,0mm	MUT005130	8056138185630	
L	5,0mm	MUT005140	8056138185647	
XL	5,0mm	MUT005150	8056138185654	
XXL	5,0mm	MUT005160	8056138185661	

WETSUITS SIZES

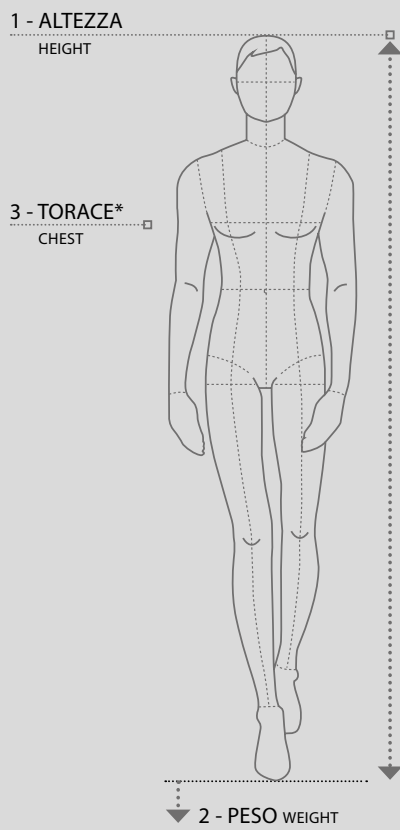

UOMO/MAN						
SIZES	1		2		3	
	ALTEZZA HEIGHT		PESO WEIGHT		TORACE CHEST	
	cm	Inch	Kg.	Lbs.	cm	Inch
S	162/175	64/69	57/69	126/152	85/92	33/36
M	172/185	68/73	67/77	148/170	93/100	37/39
L	178/188	70/74	75/88	165/194	101/115	40/45
XL	182/193	72/76	85/95	187/209	110/120	43/47
XXL	185/196	73/77	93/110	205/242	115/125	45/49

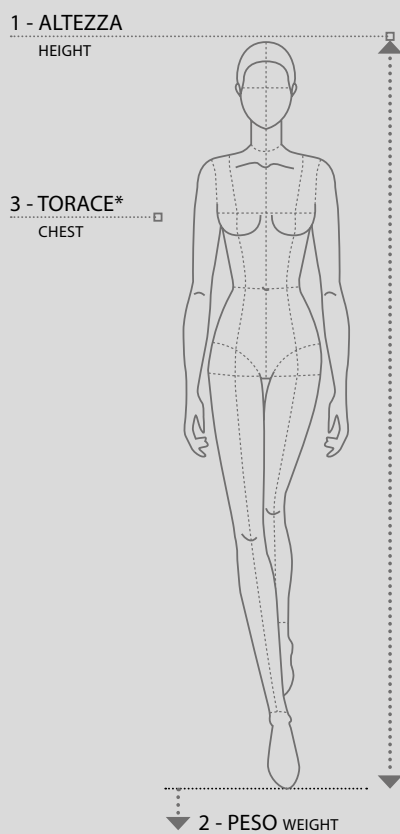

DONNA/WOMAN						
SIZES	1		2		3	
	ALTEZZA HEIGHT		PESO WEIGHT		TORACE CHEST	
	cm	Inch	Kg.	Lbs.	cm	Inch
XS	150/163	49/64	46/53	101/117	78/83	31/33
S	162/172	63/68	54/61	119/134	83/90	33/36
M	165/175	65/69	60/67	132/148	88/95	35/38
L	167/177	68/70	65/72	143/159	94/99	37/39
XL	177/186	70/73	73/80	161/176	99/104	39/41
XXL	180/190	71/75	78/90	172/198	104/114	41/45

PONCHO



- Il poncho impermeabile Salvimar è l'accessorio perfetto per completare la tua attrezzatura per tutti gli sport acquatici come pesca in apnea, freediving, surf, kitesurf e windsurf. Taglia unica, progettato con ampio cappuccio e tasche, ideale per cambiarsi in condizioni climatiche avverse
Realizzato con materiale a rapida asciugatura interna in spugna e materiale waterproof/windproof esterno

- The Salvimar waterproof changing robe is the perfect accessory to complete your equipment for all water sports such as spearfishing, freediving, surfing, kitesurfing and windsurfing. One size fits all, designed with a large hood and pockets, ideal for changing in adverse weather conditions
Made of quick-drying terrycloth inside and waterproof/windproof material outside

MATERIAL COMPOSITION:

- Outer fabric: 100% nylon
- Inner fabric: 85%polyester - 15% polyamide



Materiale interno: spugna
Inside material: terrycloth

COD.	EAN	€
ABB005	8056138183315	



TACTILE GLOVES

1,5mm



- Nuova generazione di guanti a tenuta stagna in vari spessori e per molteplici usi
- Spessore da 1.5 - 3,0 e 5,0 mm per ottimizzare le diverse esigenze termico-protettive
- Bandatura esterna in Heat Tape, neoprene CR Foam e tessuti in Ultra Stretch/Aqua-Stretch per coniugare il massimo del comfort alla percezione tattile
- Suggerito per tutte le attività subacquee e gli sport acquatici che richiedono un prodotto con caratteristiche uniche e professionali

- New generation of watertight gloves in various thicknesses and for multiple uses
- Thickness from 1.5 - 3.0 and 5.0 mm to optimise the different thermal-protective requirements
- External banding in Heat Tape, CR Foam neoprene and Ultra Stretch/Aqua-Stretch fabrics to combine maximum comfort with tactile perception
- Suggested for all diving activities and water sports that require a product with unique and professional features

SIZE	THICKNESS	COD.	EAN	€
S / 7	1,5mm	200481A	8058093688492	
M / 8	1,5mm	200481B	8058093688508	
L / 9	1,5mm	200481C	8058093688515	
XL / 10	1,5mm	200481D	8058093688522	
XXL / 11	1,5mm	200481E	8058093688539	

3,0mm



5,0mm



SIZE	THICKNESS	COD.	EAN	€
S / 7	3,0mm	200483A	8058093688546	
M / 8	3,0mm	200483B	8058093688553	
L / 9	3,0mm	200483C	8058093688560	
XL / 10	3,0mm	200483D	8058093688577	
XXL / 11	3,0mm	200483E	8058093688584	

SIZE	THICKNESS	COD.	EAN	€
S / 7	5,0mm	200485A	8058093688591	
M / 8	5,0mm	200485B	8058093688607	
L / 9	5,0mm	200485C	8058093688614	
XL / 10	5,0mm	200485D	8058093688621	
XXL / 11	5,0mm	200485E	8058093688638	

TACTILE SOCKS

1,5mm



- Nuova generazione di Calzari a tenuta stagna in vari spessori e per vari usi
- Spessore da 1.5 - 3,0 e 5,0 mm per ottimizzare le diverse esigenze termico-protettive
- Bandatura esterna in Heat Tape, suola protettiva, tessuto in nylon stretch, nuova forma anatomica. Massimo del comfort alla protezione
- Suggerito per tutte le attività subacquee e gli sport acquatici che richiedono un prodotto con caratteristiche uniche e professionali

- New generation of watertight Socks in various thicknesses and for multiple uses
- Thickness from 1.5 - 3.0 and 5.0 mm to optimise the different requirements
- External banding in Heat Tape, protective sole, stretch nylon fabric and new anatomical shape. Maximum comfort with protection
- Suggested for all diving activities and water sports that require a product with unique and professional features

SIZE	THICKNESS	COD.	EAN	€
S / 38-40	1,5mm	200581A	8058093688942	
M / 41-42	1,5mm	200581B	8058083688959	
L / 43-44	1,5mm	200581C	8058093688966	
XL / 45/46	1,5mm	200581D	8058093688973	
XXL 47/49	1,5mm	200581E	8058093688980	

3,0mm



5,0mm



SIZE	THICKNESS	COD.	EAN	€
S / 38-40	3,0mm	200583A	8058093688997	
M / 41-42	3,0mm	200583B	8058093689000	
L / 43-44	3,0mm	200583C	8058093689017	
XL / 45/46	3,0mm	200583D	8058093689024	
XXL 47/49	3,0mm	200583E	8058093689031	

SIZE	THICKNESS	COD.	EAN	€
S / 38-40	5,0mm	200585A	8058093689048	
M / 41-42	5,0mm	200585B	8058093689055	
L / 43-44	5,0mm	200585C	8058093689062	
XL / 45/46	5,0mm	200585D	8058093689079	
XXL 47/49	5,0mm	200585E	8058093689086	

SKINWIND 35 GLOVES & SOCKS



- Guanti ergonomici lisci esternamente, palmo rinforzato in materiale antiabrasione
- Gloves Ergonomic externally smooth, reinforced palm in nonscratch pattern

SIZE	THICKNESS	COD.	EAN	€
S / 7	3,5mm	200490A	8058093689147	
M / 8	3,5mm	200490B	8058093689154	
L / 9	3,5mm	200490C	8058093689161	
XL / 10	3,5mm	200490D	8058093689178	
XXL / 11	3,5mm	200490E	8058093689185	

- Calzari ergonomici lisci esternamente, pianta rinforzata in materiale antiabrasione
- Socks Ergonomic externally smooth, reinforced sole in nonscratch pattern

SIZE	THICKNESS	COD.	EAN	€
S / 38-40	3,5mm	200590A	8058093689192	
M / 41-42	3,5mm	200590B	8058093689208	
L / 43-44	3,5mm	200590C	8058093689215	
XL / 45-46	3,5mm	200590D	8058093689222	
XXL / 47-49	3,5mm	200590E	8058093689239	

DY.MAX GLOVES



EDGE COLOUR

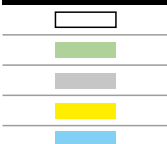

- Tessuto in filo continuo in Dy-max. Nuovo robusto palmo in nitrile. Polsino rinforzato
- The use of continuous thread of Dy-max line. The new robust palm impregnated in nitrile. Tightest cuff

SIZE	THICKNESS	COD.	EAN	€
S / 7	0,8mm	200400	8055960721320	
M / 8	0,8mm	200401	8055960721337	
L / 9	0,8mm	200402	8055960721344	
XL / 10	0,8mm	200403	8055960721351	
XXL / 11	0,8mm	200404	8055960721368	

FIT PRO SOCKS

2,0mm
FLAT LOCK stitching



4,0mm
GBS stitching



- Calzare sistema "Fitting Pro" con calzata differenziata Destro/Sinistro
- Zona frontale in tessuto super elastico evidenziato
- Ottima capacità di vestizione/svestizione
- Suola in neoprene rinforzata con applicato il sistema Honey Comb PU
- Parte superiore del frontale dita in Supratex anti abrasione
- Sistema cucitura GBS con incollaggio e doppia cucitura

- Sock with "Fitting Pro" system with differentiated right/left fit
- Front area in highlighted super elastic fabric
- Excellent dressing/undressing ability
- Reinforced neoprene sole with applied Honey Comb PU system
- Abrasion-resistant Supratex toe upper front area
- GBS stitching system with gluing and double stitching

SIZE	THICKNESS	COD.	EAN	€
S / 38-40	2,0mm	200520A	8058093684753	
M / 41-42	2,0mm	200520B	8058093684760	
L / 43-44	2,0mm	200520C	8058093684777	
XL / 45-46	2,0mm	200520D	8058093684784	
XXL 47/49	2,0mm	200520E	8058093684791	

SIZE	THICKNESS	COD.	EAN	€
S / 38-40	4,0mm	200521A	8058093684807	
M / 41-42	4,0mm	200521B	8058093684814	
L / 43-44	4,0mm	200521C	8058093684821	
XL / 45-46	4,0mm	200521D	8058093684838	
XXL 47/49	4,0mm	200521E	8058093684845	

CASPER SOCKS

AVAILABLE 2024



- Calzare corto, profilo destro e sinistro per l' utilizzo in vari sport acquatici
- Parte anteriore del piede in tessuto super elastico UT
- Suola rinforzata e antiscivolo in PU dots con disegno "Honey Comb".
- Punta in Supratex per una migliore protezione e maggiore resistenza
- Cuciture passanti Flat-Lock a doppio filo rinforzato

- Short boot, right and left profile for use in various water sports
- Front of foot made of super elastic UT fabric
- Reinforced and non-slip sole with PU dots with honeycomb design.
- Supratex toe cap for better protection, resistance to contact and rubbing
- Reinforced double thread Flat-Lock pass-through stitching

SIZE	THICKNESS	COD.	EAN	€
S / 38-40	2,0mm	CAL00220	8056138187245	
M / 41-42	2,0mm	CAL00230	8056138187252	
L / 43-44	2,0mm	CAL00240	8056138187269	
XL / 45-46	2,0mm	CAL00250	8056138187276	
XXL 47/49	2,0mm	CAL00260	8056138187283	

COMFORT GLOVES & SOCKS



GLOVES

- Nuova ergonomia Confort
- Bifoderato Nylon
- Cuciture rinforzate
- Buon potere termico
- Ottima presa

- New Confort ergonomics
- Double lined nylon
- Reinforced seams
- Good thermal power
- Excellent grip Double lined

SOCKS

- Nuova ergonomia Confort
- Bifoderato Nylon
- Cuciture rinforzate
- Buon potere termico
- Suola esterna antiscivolo

- New Confort ergonomics
- Double lined nylon
- Reinforced seams
- Good thermal power
- Non-slip outer sole

COMFORT GLOVES

SIZE	THICKNESS	COD.	EAN	€
S / 7	3,0mm	200453A	8058093685781	
M / 8	3,0mm	200453B	8058093685798	
L / 9	3,0mm	200453C	8058093685804	
XL / 10	3,0mm	200453D	8058093685811	
XXL / 11	3,0mm	200453E	8058093685828	

SIZE	THICKNESS	COD.	EAN	€
S / 7	5,0mm	200455A	8058093685835	
M / 8	5,0mm	200455B	8058093685842	
L / 9	5,0mm	200455C	8058093685859	
XL / 10	5,0mm	200455D	8058093685866	
XXL / 11	5,0mm	200455E	8058093685873	

COMFORT SOCKS

SIZE	THICKNESS	COD.	EAN	€
S / 38-40	3,0mm	200523A	8058093685682	
M / 41-42	3,0mm	200523B	8058093685699	
L / 43-44	3,0mm	200523C	8058093685705	
XL / 45-46	3,0mm	200523D	8058093685712	
XXL 47/49	3,0mm	200523E	8058093685729	

SIZE	THICKNESS	COD.	EAN	€
S / 38-40	5,0mm	200525A	8058093685736	
M / 41-42	5,0mm	200525B	8058093685743	
L / 43-44	5,0mm	200525C	8058093685750	
XL / 45-46	5,0mm	200525D	8058093685767	
XXL 47/49	5,0mm	200525E	8058093685774	

KRYPSIS GLOVES & SOCKS



GLOVES

- Potere termico Elevato
- Super elastico
- Ottima vestibilita
- Palmo esterno con rinforzo

- High thermal power
- Super elastic outside
- Excellent fit
- Reinforced palm outside

SOCKS

- Potere termico Elevato
- Super elastico
- Ottima vestibilita
- Plantare esterno allungato con rinforzo
- Open cell

- High thermal power
- Super elastic outside
- Elongated outer footbed with reinforcement
- Elongated outer footbed with reinforcement
- Open cell

COMFORT GLOVES

SIZE	THICKNESS	COD.	EAN	€
S / 7	3,0mm	200470A	8058093685101	
M / 8	3,0mm	200470B	8058093685118	
L / 9	3,0mm	200470C	8058093685125	
XL / 10	3,0mm	200470D	8058093685132	
XXL / 11	3,0mm	200470E	8058093685149	

SIZE	THICKNESS	COD.	EAN	€
S / 7	5,0mm	200475A	8058093685156	
M / 8	5,0mm	200475B	8058093685163	
L / 9	5,0mm	200475C	8058093685170	
XL / 10	5,0mm	200475D	8058093685187	
XXL / 11	5,0mm	200475E	8058093685194	

COMFORT SOCKS

SIZE	THICKNESS	COD.	EAN	€
S / 38-40	3,5mm	200560A	8058093685200	
M / 41-42	3,5mm	200560B	8058093685217	
L / 43-44	3,5mm	200560C	8058093685224	
XL / 45-46	3,5mm	200560D	8058093685231	
XXL 47/49	3,5mm	200560E	8058093685248	

SIZE	THICKNESS	COD.	EAN	€
S / 38-40	5,5mm	200565A	8058093685255	
M / 41-42	5,5mm	200565B	8058093685262	
L / 43-44	5,5mm	200565C	8058093685279	
XL / 45-46	5,5mm	200565D	8058093685286	
XXL 47/49	5,5mm	200565E	8058093685293	

KRYPSIS BACK PACK



LEAD ANKLE
PAG. 121



- Schienalino ergonomico, spallacci in neoprene per il massimo comfort
- Nuove tasche porta piombi per un'ottima distribuzione dei pesi
- 6kg di cui n°4 posteriori in linea e n° 2 anteriori

- Ergonomic back pack, neoprene shoulder straps for extreme comfort
- New optimal weight distribution
- 6kg of which 4 rear in line and 2 front

SIZE	COD.	EAN	€
M - L	200318B	8058093685316	
XL - XXL	200318C	8058093685323	



TERMAL TECH

- Sottomuta 2,0 mm in materiale super elastico
- Materiale esterno: Smooth Skin JAKO MSL
- Materiale interno: Fodera elastica Ultra Tender
- Cucitura: Sistema GBS waterproof
- 2.0 mm undersuit made of super elastic material
- Outer material: Smooth Skin JAKO MSL
- Inner material Ultra Tender elastic lining
- Seams: GBS waterproof system

SIZE	THICKNESS	COD.	EAN	€
S	2mm	ACNEO0031	8056138183261	
M	2mm	ACNEO0032	8056138183278	
L	2mm	ACNEO0033	8056138183308	
XL	2mm	ACNEO0034	8056138183285	
XXL	2mm	ACNEO0035	8056138183292	



DROP BACK PACK

- Schienalino ergonomico, spallacci in neoprene per il massimo comfort - 6kg
- Ergonomic back pack, neoprene shoulder straps for extreme comfort - 6kg

SIZE	COD.	EAN	€
S - M	200310	8055960721290	
L - XL	200312	8055960721306	
XL - XXL	200315	8055960721313	



BERMUDA

- Bermuda a vita alta, taglio preformato
- High-waist bermuda, preformed cut

SIZE	THICKNESS	COD.	EAN	€
M	2,5mm	200240	8055960723126	
L	2,5mm	200241	8055960723140	
XL	2,5mm	200242	8055960723157	
XXL	2,5mm	200243	8055960723188	

P.CHANNEL



- Accessorio in neoprene spaccato da 3,5 mm per ovviare ad esigenze fisiologi che durante l'utilizzo pro lungato della muta. Estremamente elastico, base in neoprene spaccato per una semplice applicazione
- Open cell Neoprene accessory, 3,5 mm, made to deal with physiological needs during extended use of the wetsuit. Very elastic, made in open cell neoprene for easy wearing

PIT STOP CR TROUSERS



- Pantalone con "pissette" assemblata
- Materiale esterno: fodera in Nylon super elastico.
- Materiale interno: neoprene spaccato Q-FOAM "open cell"
- Cuciture: Sistema GBS waterproof
- Trousers with set up "pissette"
- External material: super stretch Nylon lining
- Inside material: Open cell Neoprene Q-FOAM
- Seams: GBS waterproof System

SIZE	THICKNESS	COD.	EAN	€
S	5,5mm	MUT001020	8056138180833	
M	5,5mm	MUT001030	8056138180840	
L	5,5mm	MUT001040	8056138180857	
XL	5,5mm	MUT001050	8056138180864	
XXL	5,5mm	MUT001060	8056138180871	



COLOR	THICKNESS	COD.	EAN	€
BLACK	3,5mm	ACNEO0010	8056138181069	
KRYPISIS CAMU	3,5mm	ACNEO0011	8056138181076	

PLASTIC SNAP BUTTON



- Clip di chiusura muta (3,5 - 5,5 - 7,0mm) a sgancio rapido corredato di viti di fissaggio in acciaio Inox
- Quick-release wetsuit fastening clips (3.5 - 5.5 - 7.0mm) with fixing screws in stainless steel

PAIR	COD.	EAN	€
n° 1	200100	8056138180062	

MASTICE PER MUTE



- Mastice per riparazioni mute - 30gr
- Wetsuit repair glue - 30gr

COD.	EAN	€
400600	8058093681714	

► Suggested Pack: 15 pz

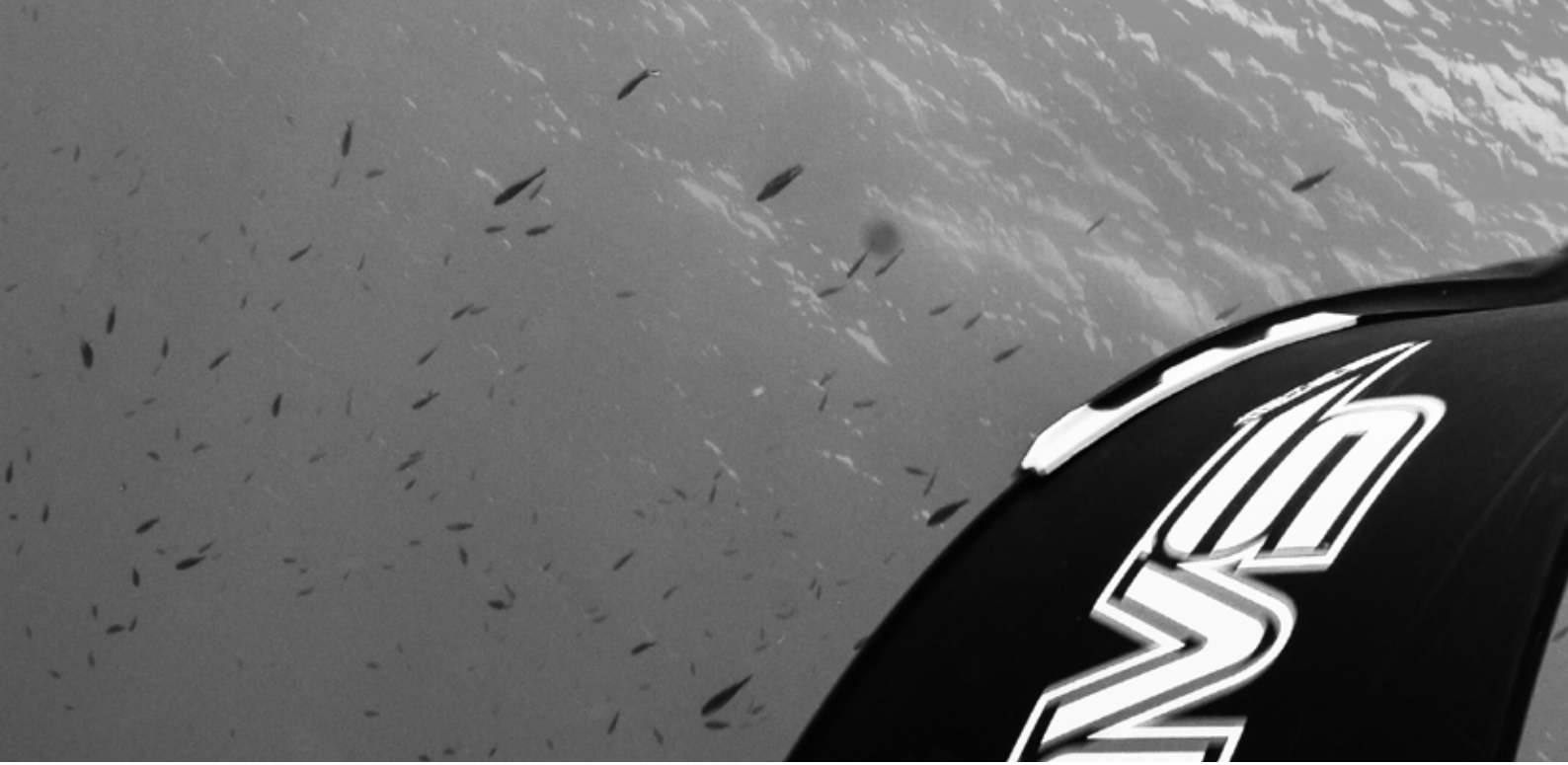



F I N S



Le scarpette speeder sono il risultato di un approccio tecnico di studio della forma, della struttura e dei materiali; sono state pensate per superare le prestazioni delle pinne di precedente generazione e migliorare il comfort della calzata.

1 - Longheroni Sottomessi alla Pianta del Piede

La nostra tecnologia di longheroni sottomessi permette di migliorare la resa dello sforzo, garantendo la massima efficienza ad ogni movimento. Questa innovazione aumenta l'idrodinamica della pinna, permettendo spostamenti in acqua più fluidi. I longheroni sono completati da clip rigide costampate che rendono solidale la scarpetta alla pala migliorando il trasferimento energetico.

2 - Soletta Rigida Integrata

La scarpetta Speeder ingloba in fase di stampaggio una soletta polipropilene che garantisce rigidità alla scarpetta mantenendo una tomaia morbida e leggera. Inoltre, permette di migliorare, insieme alle clip dei longheroni, l'adesione tra pala e scarpetta rendendo la pinna un tutt'uno. Questa soluzione innovativa ha permesso l'utilizzo di una gomma morbida e sottile che avvolge il piede mantenendo un'ottima spinta sulle pale.

3 - Scarpetta a Spessore Differenziato

La scelta dei materiali ha permesso di ottimizzare il peso e la resistenza delle nostre pinne da apnea grazie a una scarpetta a spessore differenziato e alla forma studiata appositamente per poter alleggerire la scarpetta senza perdere di robustezza.

4 - Il Frontale Innovativo

Il disegno del frontale è stato particolarmente curato: per proteggere le dita è stata chiusa la parte anteriore della tomaia per non compromettere il comfort e l'efficienza della scarpetta è stata ricavata una nicchia per l'alluce all'interno del longherone che garantisce il perfetto allineamento piede-ginocchio e quindi una pinneggiata stabile. Questo nuovo concetto di design offre il massimo comfort e una calzabilità perfetta.

FINS

SALVIMAR SPEARFISHING

SPEEDER FOOT POCKETS

55
SHORE



The Speeder foot pockets are the result of a technical approach of studying shape, structure and materials; they have been designed to exceed the performance of previous generation fins and improve the comfort of the fit.

1 - Spars under the Footbed

Our technology with underlying spars enables to improve the yield of effort, ensuring maximum efficiency with every movement. This innovation increases the hydrodynamics of the fin, allowing smoother movements in the water. The spars are completed by rigid co-molded clips that make the foot pocket integral with the blade, improving the energy transfer.

2 - Integrated Rigid Insole

The Speeder foot pocket incorporates a polypropylene insole during molding that provides rigidity while maintaining a soft and light upper. Furthermore, it allows to improve, together with the spar clips, the adhesion between the blade and the foot pocket, making the fin a single whole. This innovative solution has allowed the use of a soft and thin rubber that wraps around the foot while maintaining an excellent thrust on the blades.

3 - Differentiated Thickness Foot Pocket

The choice of materials has made it possible to optimise the weight and strength of our freediving fins thanks to a foot pocket with a differentiated thickness and a shape specifically designed to be able to lighten the foot pocket without losing robustness.

4 - The Innovative Front Piece

The design of the front has been particularly careful: to protect the toes, the front part of the upper has been closed so as not to compromise the comfort and efficiency of the foot pocket, a niche for the big toe has been created inside the spar that guarantees the perfect foot-knee alignment and therefore a stable finning. This new design concept offers maximum comfort and perfect fit.

SPEEDER HD FOOT POCKETS

NEW
ARRIVAL

65
SHORE



SPEEDER



La pinna Speeder è frutto di un attento lavoro di ricerca sulla dinamica del movimento. L'innovativa scarpetta è rinforzata con una soletta rigida posta sotto la pianta del piede, questo consente un trasferimento di energia ottimale durante la pinneggiata. Angolo di 29 gradi, soletta rigida e longheroni laterali che girano sotto la pianta del piede conferiscono alla scarpetta una struttura meccanica senza eguali ma soprattutto la possibilità di utilizzare gomme anche molto morbide per un comfort eccezionale.

Durante la fase di sviluppo oltre ad aver prestato particolare attenzione alle caratteristiche dei due componenti che costituiscono una pinna, scarpetta e pala, abbiamo implementato l'interazione fra di essi attraverso il perfezionamento del sistema di innesto, migliorando di fatto la funzionalità complessiva del prodotto.

- La pala realizzata a stampo in polipropilene garantisce un'ottima spinta propulsiva e un ottimo ritorno elastico pur minimizzando lo sforzo di pinneggiata.
- La pala è stata realizzata a spessore differenziato: il tallone ha uno spessore di 3,5mm la punta ha uno spessore di 1,8 mm

The Speeder fin is the result of a careful research into the dynamics of movement. The innovative foot pocket is reinforced with a rigid insole placed under the sole of the foot; this allows optimal energy transfer during finning.

29-degree angle, rigid insole and side spars that turn under the sole of the foot give the foot pocket an unparalleled mechanical structure but above all the possibility of using even very soft rubbers for exceptional comfort.

During the development phase, in addition to paying particular attention to the characteristics of the two components that make up a fin, foot pocket and blade, we implemented the interaction between them through the improvement of the coupling system, effectively improving the overall functionality of the product.

- The molded polypropylene blade ensures better propulsive thrust and excellent springback while minimising the finning effort
- The blade has been made with a differentiated thickness: the heel has a thickness of 3.5 mm, the toe has a thickness of 1.8 mm

SPEEDER

SIZE EU	SIZE US	COD.	EAN	€
39/40	5½/7	PIN01039	8056138180741	
41/42	8/8½	PIN01041	8056138180758	
43/44	9½/10	PIN01043	8056138180765	
45/46	11/12	PIN01045	8056138180772	

BLADE SPARE PARTS

MODEL	PACK	COD.	EAN	€
SPEEDER	1pz	PPIN010	8056138184367	

SPEEDER CARBO



La pinna Speeder Carbo si pone ai vertici assoluti della categoria. Il carbonio grazie all'elevato modulo elastico e alla leggerezza che lo contraddistinguono offre una migliore resa a parità di sforzo applicato.

La pala in fibra di carbonio TW-K03 Pre-Peg ad elevato modulo è realizzata in autoclave. Per evitare la presenza di bolle d'aria e punti deboli, abbiamo ottimizzato la quantità di resina che lega tra loro le fibre di carbonio. Il carbonio K03 offre prestazioni elevatissime per la costruzione di pale, ottima è la risposta alla flessione e la resistenza all'urto. L'innovativo processo di applicazione degli strati di carbonio, consente di ottenere una struttura a spessore differenziato molto precisa riuscendo a calibrare l'esatta dimensione della pala nei punti di flessione e di spinta.

The Speeder Carbo fin stands at the absolute top of its class.

Carbon, thanks to its high elastic modulus and its distinctive lightness, offers better performance with the same applied effort.

The high-modulus TW-K03 Pre-Peg carbon fiber blade is made in an autoclave.

To avoid the presence of air bubbles and weak points, we have optimised the amount of resin that binds the carbon fibers together. K03 carbon offers very high performance for the construction of blades, excellent bending response and impact resistance. The innovative process of applying the carbon layers makes it possible to obtain a very precise differentiated thickness structure, managing to calibrate the exact size of the blade at the bending and thrust points.

SPEEDER CARBO

SIZE EU	SIZE US	COD.	EAN	€
39/40	5½/7	PIN02039	8056138184084	
41/42	8/8½	PIN02041	8056138184091	
43/44	9½/10	PIN02043	8056138184107	
45/46	11/12	PIN02045	8056138184114	

BLADE SPARE PARTS

MODEL	PACK	COD.	EAN	€
CARBO SPEEDER	1pz	PPIN020	8056138184374	

SPEEDER HD

NEW ARRIVAL



La pinna SpeederHD è indicata per i fisici più allenati. Questo grazie alla combinazione di maggiore consistenza della scarpetta e di rigidità della pala. L'innovativa scarpetta è rinforzata con una soletta rigida posta sotto la pianta del piede, questo consente un trasferimento di energia ottimale durante la pinneggiata. Angolo di 29 gradi, soletta rigida e longheroni laterali che girano sotto la pianta del piede conferiscono alla scarpetta una struttura meccanica senza eguali ma soprattutto la possibilità di utilizzare gomme anche molto morbide per un comfort eccezionale. Durante la fase di sviluppo oltre ad aver prestato particolare attenzione alle caratteristiche dei due componenti che costituiscono una pinna, scarpetta e pala, abbiamo implementato l'interazione fra di essi attraverso il perfezionamento del sistema di innesto, migliorando di fatto la funzionalità complessiva del prodotto.

- La Pala realizzata a stampo in polipropilene garantisce unamigliore spinta propulsiva e un ottimo ritorno elastico pur minimizzando lo sforzo di pinneggiata.
- La pala è stata realizzata a spessore differenziato: il tallone ha uno spessore di 3,5mm la punta ha uno spessore di 1,8 mm

The SpeederHD fin is suitable for the more trained physiques. This is thanks to the combination of greater foot pocket consistency and blade rigidity. The innovative foot pocket is reinforced with a rigid insole placed under the sole of the foot; this allows optimal energy transfer during finning. 29-degree angle, rigid insole and side spars that turn under the sole of the foot give the foot pocket an unparalleled mechanical structure but above all the possibility of using even very soft rubbers for exceptional comfort. During the development phase, in addition to paying particular attention to the characteristics of the two components that make up a fin, foot pocket and blade, we implemented the interaction between them through the improvement of the coupling system, effectively improving the overall functionality of the product.

- The molded polypropylene blade ensures better propulsive thrust and excellent springback while minimising the finning effort.
- The blade has been made with a differentiated thickness: the heel has a thickness of 3.5 mm, the toe has a thickness of 1.8 mm

SPEEDER HD

SIZE EU	SIZE US	COD.	EAN	€
39/40	5½/7	PIN01539	8056138186866	
41/42	8/8½	PIN01541	8056138186873	
43/44	9½/10	PIN01543	8056138186880	
45/46	11/12	PIN01545	8056138186897	

BLADE SPARE PARTS

MODEL	PACK	COD.	EAN	€
SPEEDER	1pz	PPIN010	8056138184367	

SPEEDER HD CARBO

NEW ARRIVAL



La pinna Speeder HD Carbo è indicata per i fisici più allenati che cercano le migliori prestazioni. Questo grazie alla combinazione di maggiore consistenza della scarpetta e alla scelta diversa stratificazione delle fibre di carbonio. Il carbonio grazie all'elevato modulo elastico e alla leggerezza che lo contraddistinguono offre una migliore resa a parità di sforzo applicato. La pala in fibra di carbonio TW-K03 Pre-Peg ad elevato modulo è realizzata in autoclave. Per evitare la presenza di bolle d'aria e punti deboli, abbiamo ottimizzato la quantità di resina che lega tra loro le fibre di carbonio. Il carbonio K03 offre prestazioni elevatissime per la costruzione di pale, ottima è la risposta alla flessione e la resistenza all'urto. L'innovativo processo di applicazione degli strati di carbonio, consente di ottenere una struttura a spessore differenziato molto precisa riuscendo a calibrare l'esatta dimensione della pala nei punti di flessione e di spinta.

The Speeder HD Carbo fin is suitable for fitter physiques looking for the best performance. This is thanks to the combination of greater foot pocket consistency and the different layering choice of the carbon fibers. Carbon, thanks to its high elastic modulus and its distinctive lightness, offers better performance with the same applied effort. The high-modulus TW-K03 Pre-Peg carbon fiber blade is made in an autoclave. To avoid the presence of air bubbles and weak points, we have optimised the amount of resin that binds the carbon fibers together. K03 carbon offers very high performance for the construction of blades, excellent bending response and impact resistance. The innovative process of applying the carbon layers makes it possible to obtain a very precise differentiated thickness structure, managing to calibrate the exact size of the blade at the bending and thrust points.

SPEEDER HD CARBO

SIZE EU	SIZE US	COD.	EAN	€
39/40	5½/7	PIN02539	8056138188815	
41/42	8/8½	PIN02541	8056138188822	
43/44	9½/10	PIN02543	8056138188839	
45/46	11/12	PIN02545	8056138188846	

BLADE SPARE PARTS

MODEL	PACK	COD.	EAN	€
CARBO SPEEDER	1pz	PPIN020	8056138184374	

COME SCEGLIERE LA MISURA DELLA SCARPETTA

HOW TO CHOOSE THE SIZE OF THE FOOT POCKET

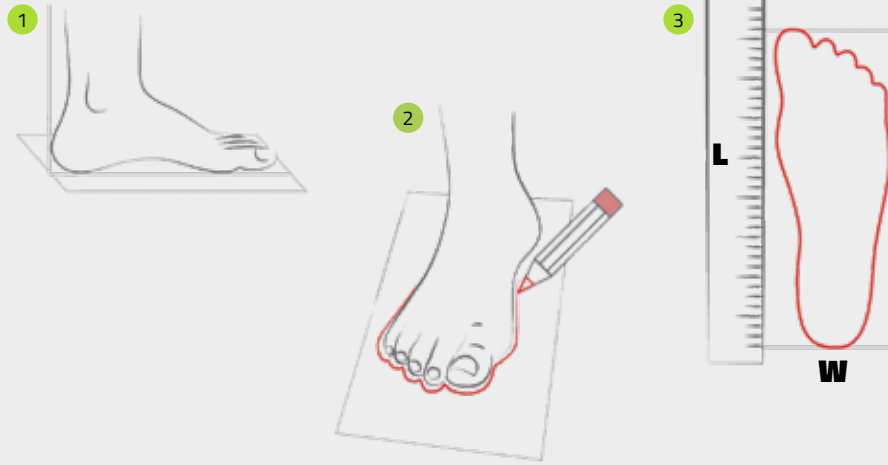

1 **Indossa il calzare** dello spessore desiderato, appoggia il tallone alla parete e posa il piede sul foglio
Wear the sock of the desired thickness, lean your heel against the wall and place your foot on the sheet

2 Misura il disegno dal tallone al dito più lungo
 Measure the design from the heel to the longest toe

3 Segna la lunghezza e la larghezza della pianta del piede
 Mark the length and width of the sole of the foot

4 Confronta le misure con la tabella di riferimento sotto riportata e scegli la scarpetta corrispondente
 Compare the measurements with the reference table below and choose the corresponding foot pocket

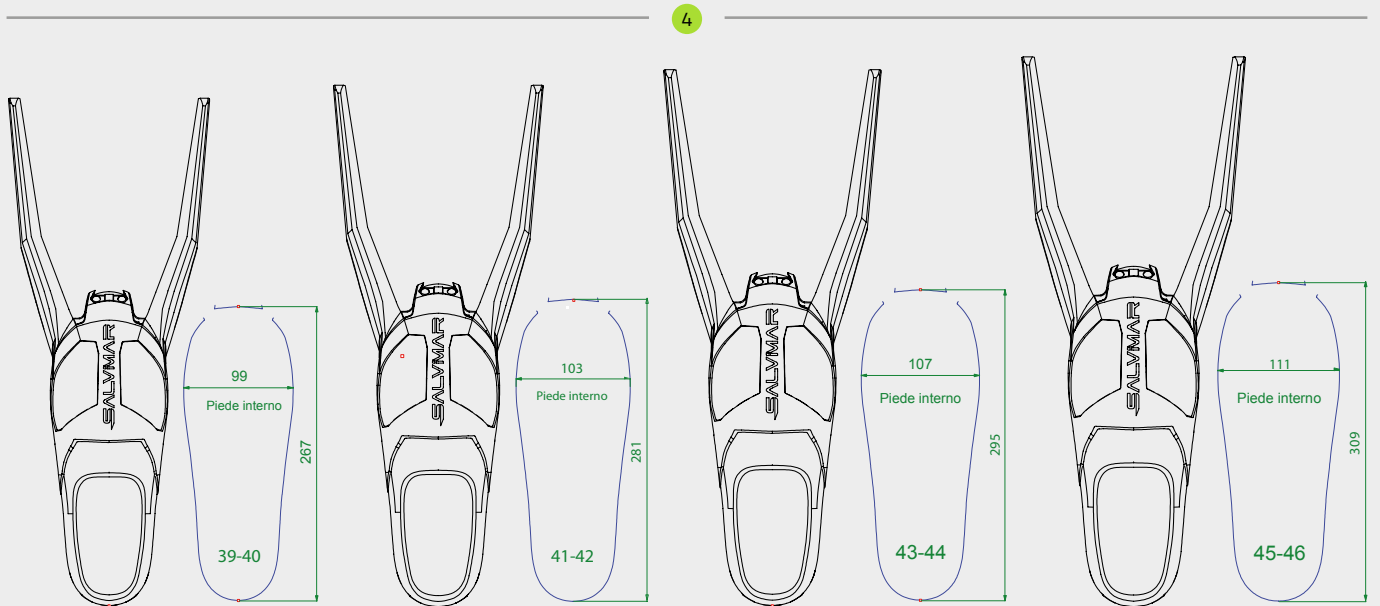

GUIDA ALLE TAGLIE / SHOE SIZE

LENGTH	WIDTH	EU	UK	USA
26,7 cm	9,9 cm	39/40	6	7
28,1 cm	10,3 cm	41/42	7/8	8/9
29,5 cm	10,7 cm	43/44	9/10	10/11
30,9 cm	11,1 cm	45/46	11/12	12/13

K-REINFORCED



- Scarpetta in gomma naturale 55 shore
- Massimo comfort e resistenza
- Natural rubber 55 shore stiffness
- Maximum comfort and strength



BLADE SPARE PARTS

MODEL	PACK	COD.	EAN	€
BLADES FIXING KIT	1pz	AQ050	8055960724390	

SIZE EU	SIZE US	COD.	EAN	€
38/40	5½/7	AQ005C	8058093680359	
41/42	8/8½	AQ007C	8058093680366	
43/44	9½/10	AQ009C	8058093680373	
45/46	11/12	AQ011C	8058093680380	
47/49	13/14	AQ013C	8058093680397	

STEP



- Scarpetta in termoplastica, 60 shore a spessori differenziati
- Angolo scarpetta/pala 20°
- Synthetic rubber foot pocket, 60 shore with 20-degree blade angle

SIZE EU	SIZE US	COD.	EAN	€
36/37	4/ 4½	600200Y	8058093681943	
38/39	5½/7	600200Z	8057685556980	
40/41	8/8½	600200A	8055960723706	
42/43	9½/10	600200B	8055960728268	
44/45	11/12	600200C	8055960728275	
46/47	13/14	600200D	8055960728282	

TURN 151



- Angolo scarpetta/pala inclinato a 29°
- Pala in Polipropilene a spessore differenziato
- Spessore differenziato per migliorare la risposta elastica
- Scarpetta in gomma naturale 55 shore

- Foot pocket / blade angle 29 Degrees
- Polypropylene blade with differentiated thickness
- Differentiated thickness to improve power retention
- Natural rubber 55 shore stiffness

ACID GREEN TURN 151

SIZE EU	SIZE US	COD.	EAN	€
38/40	5½/7	600100AG	8058093686900	
41/42	8/8½	600100BG	8058093686917	
43/44	9½/10	600100CG	8058093686924	
45/46	11/12	600100DG	8058093686931	
47/49	13/14	600100EG	8058093686948	

BLADE SPARE PARTS

MODEL	PACK	COD.	EAN	€
TURN151 BLADE	1pz	600100	8057685559790	
TURN151 BLADE GREEN	1pz	600100GA	8058093687150	

BLACK TURN 151

SIZE EU	SIZE US	COD.	EAN	€
38/40	5½/7	600100A	8057685559363	
41/42	8/8½	600100B	8057685559370	
43/44	9½/10	600100C	8057685559387	
45/46	11/12	600100D	8057685559400	
47/49	13/14	600100E	8057685559394	

BOOMBLAST DYNAMIC



- Pala in fibre di carbonio Pre-Peg TW-K03 ad alto modulo
- Polimerizzata meccanicamente a pressioni elevatissime in autoclave
- Grado di compattezza strutturale senza uguali
- Spessore differenziato per migliorare la risposta elastica
- Canalizzatori d'acqua laterali ribassati per ridurre lo sforzo di pinneggiata
- Scarpetta in gomma naturale 55 shore

- Blade in Pre-Preg TW-K03 high modulus carbon fiber
- Construction: Mechanically polymerized high pressure Autoclave molding
- Structural Integrity AKA Strength with "No Equals"
- Differentiated thickness to improve power retention
- Lowered side water channellers to make kicking easier
- Natural rubber 55 shore stiffness

BOOMBLAST DYNAMIC

SIZE EU	SIZE US	COD.	EAN	€
38/40	5½/7	600050A	8055960726219	
41/42	8/8½	600050B	8055960726226	
43/44	9½/10	600050C	8055960726233	
45/46	11/12	600050D	8055960726240	
47/49	13/14	600050E	8055960726257	

BLADE SPARE PARTS

MODEL	PACK	COD.	EAN	€
BOOMBLAST BLADE	1pz	600050	8055960726264	
EDGES	1Kit	400264	8055960724857	

CARBO 151



- Angolo scarpetta/pala inclinato a 29°
- Pala in fibra di carbonio Pre-Peg TW-K03 ad alto modulo
- Polimerizzata meccanicamente a pressioni elevatissime in autoclave
- Grado di compattezza strutturale senza uguali
- Scarpetta in gomma naturale 55 shore

- Footpocket / blade angle 29 Degrees
- Blade in Pre-Preg TW-K03 high modulus carbon fiber
- Construction: Mechanically polymerized high pressure Autoclave molding
- Structural Integrity AKA Strength with "No Equals"
- Natural rubber 55 shore stiffness

CARBO 151

SIZE EU	SIZE US	COD.	EAN	€
38/40	5½/7	600300A	8057685559806	
41/42	8/8½	600300B	8057685559813	
43/44	9½/10	600300C	8057685559820	
45/46	11/12	600300D	8057685559837	
47/49	13/14	600300E	8057685559844	

BLADE SPARE PARTS

MODEL	PACK	COD.	EAN	€
CARBO151 BLADE	1pz	600300	8057685559776	
EDGES	1Kit	400264	8055960724857	

FIBRA 151



- Angolo scarpetta/pala inclinato a 29°
- Pala in fibra
- Grado di compattezza struttura le senza uguali
- Scarpetta in gomma naturale 55 shore
- Pala a spessori differenziati

- Footpocket / blade angle 29 Degrees
- Blade in fiber
- Structural Integrity AKA Strength with "No Equals"
- Natural rubber 55 shore stiffness
- Blade with differentiated thickness

FIBRA 151

SIZE EU	SIZE US	COD.	EAN	€
38/40	5½/7	000093A	8057685558397	
41/42	8/8½	000093B	8057685558403	
43/44	9½/10	000093C	8057685558410	
45/46	11/12	000093D	8057685558427	
47/49	13/14	000093E	8057685558434	

BLADE SPARE PARTS

MODEL	PACK	COD.	EAN	€
FIBRA151 BLADE	1Kit	000093	8058093680113	

REACT



- Pinna con pala amovibile in Polipropilene
- Scarpetta in termo plastica 60 shore
- Canalizzazione dell'acqua controllata
- Pala con terminale idrodinamico

- Modular Freediving fin with Polypropylene interchangeable blade
- Shore 60 stiffness synthetic ubber foot pockets
- Controlled water channelling
- Blade with hydrodynamic terminal

REACT

SIZE EU	SIZE US	COD.	EAN
36/37	4/ 4½	600106/Y	8058093681936
38/39	5½/7	600106/Z	8057685556997
40/41	8/8½	600106/A	8055960723690
42/43	9½/10	600106/B	8055960727377
44/45	11/12	600106/C	8055960727384
46/47	13/14	600106/D	8055960727391

BLADE SPARE PARTS

MODEL	PACK	COD.	EAN
REACT BLADE	1pz	600206	8055960728244



M A S K S



NOAH



- Maschera a volume estremamente ridotto
- Tecnologia innovativa con telaio inserito per fusione
- Naso preformato 3D comfort
- Ottimo campo visivo
- Fibbia regolabile con fissaggio micrometrico del cinturino
- Vetro temperato ultra resistente
- Silicene interno opaco per evitare la riflessione della luce
- Facciale in silicone anallergico
- Design e Technical Concept made in Salvimar

- Low volume universal fitting mask with excellent field of vision
- Fusion insertion frame for lightweight and low profile design
- 3D nose design for comfort
- Unmatched field of vision to volume ratio
- Adjustable buckles with micro adjustability
- Tempered ultra-resistant glass
- Matt finish interior to avoid reflections
- Antiallergenic silicone skirt
- Exclusive Salvimar design



GREY - GREY



BLACK - GREEN



GREEN - BLACK



BLACK - BLACK



BLACK - ACID GREEN



WHITE - BLUE

► Suggested Pack: 12 pz

WEIGHT	COLOR	COD.	EAN	€
140,00gr.	SHINING BLUE	7000SG	8056138184787	
NEW 140,00gr.	GREY/GREY	7000GG	8056138186248	
140,00gr.	BLACK - GREEN	7000BG	8057685556959	
140,00gr.	GREEN - BLACK	7000GB	8057685556966	
140,00gr.	BLACK - BLACK	7000BB	8057685556942	
140,00gr.	BLACK - ACID GREEN	000053G	8057685557017	
140,00gr.	WHITE - BLUE	000053WB	8057685557338	

HATHOR



- Maschera da Pesca e Apnea dal volume estremamente ridotto con ergonomia lenti ad alta visibilità
- Realizzata interamente in silicone anallergico fuso su telaio in nylon, lenti in vetro temperato fuse nel telaio portante.
- Il volume interno ridotto agevola la fase di compensazione, il profilo che aderisce sul viso ha dimensioni calcolate per non interferire con lo spazio visivo
- La regolazione del cinghiolo è semplice e intuitiva, ha un'ergonomia che si adatta alla testa senza creare pressione sulle orecchie
- L'ampiezza del campo visivo consente un'ottima visibilità laterale

- Extremely low volume spearfishing and freediving mask with ergonomic great visibility lenses
- Made entirely of hypoallergenic silicone fused on a nylon frame, tempered glass lenses fused to the supporting frame
- The reduced internal volume facilitates the equalisation phase, the profile that adheres to the face has dimensions calculated so as not to interfere with the visual space
- The strap adjustment is simple and intuitive and the strap itself has an ergonomic fit that adapts to the head without creating pressure on the ears
- The excellent field of view allows excellent lateral visibility



SHINNING BLUE



BLACK



MILITARY GREEN

► Suggested Pack: 12 pz

WEIGHT	COLOR	COD.	EAN	€
138,00 gr.	KRYPISIS	7800K	8056138180987	
NEW 138,00 gr.	SHINNING BLUE	7800SB	8056138187061	
138,00 gr.	BLACK	7800B	8056138180215	
138,00 gr.	MILITARY GREEN	7800G	8056138181144	

MIMIC



- L'Innovativo design del facciale, permette di mantenere un ottimo campo visivo
- L'inclinazione del facciale sulla zona della fronte consente alle lenti di avvicinarsi agli occhi senza intervenire con il movimento naturale delle ciglia
- Fissaggio del cinturino su attacco sferico a telaio, ciò permette un perfetto orientamento del cinghiolo ed una precisa regolazione della tensione, cioè favorisce la manovra di compensazione
- Maschera a volume estremamente ridotto
- Tecnologia innovativa con telaio inserito per fusione
- Naso preformato 3D comfort
- Ottimo campo visivo
- Fibbia regolabile con fissaggio micrometrico del cinturino
- Vetro temperato ultra resistente
- Silicone interno opaco per evitare la riflessione della luce
- Facciale in silicone anallergico
- Design e Technical Concept made in Salvimar

- The innovative design of the facepiece allows to maintain an excellent field of view
- The inclination of the facepiece on the forehead area allows the lenses to approach the eyes without interfering with the natural movement of the eyelashes
- Fastening of the strap on a spherical frame attachment, which allows a perfect orientation of the strap and a precise adjustment of the tensioning, this favours the equalization manoeuvre
- Low volume universal fitting mask with excellent field of vision
- Fusion insertion frame for lightweight and low profile design
- 3D nose design for comfort
- Unmatched field of vision to volume ratio
- Adjustable buckles with micro adjustability
- Tempered ultra-resistant glass
- Matt finish interior to avoid reflections
- Antiallergenic silicone skirt
- Exclusive Salvimar design

► Suggested Pack: 12 pz



MILITARY GREEN

WEIGHT	COLOR	COD.	EAN	€
130,00 gr.	BLACK	7900B	8056138181212	
130,00 gr.	MILITARY GREEN	7900G	8056138181229	

FLY



MILITARY GREEN

- Maschera minimale
- Fibbia regolabile con fissaggio micrometrico del cinturino
- Compensazione agevolata
- Tecnologia monoblocco 3 materiali fusi assieme
- Forma lenti studiate per ottimo campo visivo
- Silicone interno ed esterno antiriflesso
- Densità silicone super confort

- Minimal mask
- Adjustable buckles with micro adjustability
- Easy compensation
- One-piece technology 3 materials melted together
- Lens shape designed for excellent field of vision
- Anti-reflective silicone inside and outside
- Super comfort silicone density

► Suggested Pack: 12 pz

WEIGHT	COLOR	COD.	EAN	€
138,00 gr.	BLACK	7700B	8058093686498	
138,00 gr.	MILITARY GREEN	7700G	8058093686481	

MORPHEUS



- Ottimo campo visivo, telaio bioculare ribassato centralmente
- Naso preformato 3D comfort
- Fibbia regolabile con fissaggio micrometrico del cinturino
- Vetro temperato ultra resistente
- Facciale in silicone anallergico
- Design e Technical Concept made in Salvimar

- Two lenses mask, lower frame enlarging the visual field
- 3D comfort nose
- Micrometrically adjustable strap
- Tempered highly resistant glass
- Hypoallergenic silicon skirt
- Design and technical concept made in Salvimar

► Suggested Pack: 12 pz



BLACK - BLACK



BLACK - GREEN



BLUE - CLEAR



YELLOW - CLEAR

WEIGHT	COLOR	COD.	EAN	€
150,00gr.	SHINING BLUE	000060SB	8056138182837	
150,00gr.	BLACK - BLACK	7400BB	8058093680120	
150,00gr.	BLACK - GREEN	7400BG	8057685559332	
150,00gr.	BLUE - CLEAR	000060BL	8058093680717	
150,00gr.	YELLOW - CLEAR	000060G	8058093680724	

TRINITY



- Maschera in silicone con attacco Action Cam integrato
- Vetro temperato
- Silicone anallergico di alta qualità
- Volume interno ridotto, conferisce un'ottima visibilità e aderenza
- Adatta per free diving, spearfishing, snorkeling e scuba diving
- L'attacco integrato Action Cam permette di montare facilmente la action-cam e di registrare video e foto in modo semplice riprendendo esattamente ciò che stai guardando

- Silicone mask with integrated Action Cam Attachment
- Tempered glass
- High-quality antiallergic silicone
- Reduced internal volume, gives a large visual field and adherence
- Suitable for free diving, spearfishing, snorkelling and scuba diving
- The integrated Action Cam attachment allows to easily mount the action - cam and to record videos and photos simply by taking exactly what you are looking at



CLEAR - BLUE

► Suggested Pack: 12 pz

WEIGHT	COLOR	COD.	EAN	€
172,00gr	BLACK - BLACK	7500BB	8058093680649	
172,00gr	CLEAR - BLUE	000061BL	8058093680731	

NEO



- Maschera a vetro portante
- Ampio campo visivo
- Naso preformato 3D comfort
- Fibbia regolabile con fissaggio micrometrico del cinturino
- Facciale in silicone anallergico
- Design e Technical Concept made in Salvimar

- Monoframe mask
- Large visual field
- Nose pocket preformed 3D design for comfort
- Adjustable buckle with micro strap adjustment
- Tempered ultra-resistant glass
- Antiallergic silicone skirt
- Exclusive Salvimar design

► Suggested Pack: 12 pz



SHINNING BLUE



BLACK



MILITARY GREEN



WHITE

WEIGHT	COLOR	COD.	EAN	€
170,00gr.	PETROL	SN051	8056138182806	
NEW 170,00gr.	SHINNING BLUE	7300SB	8056138187078	
170,00gr.	BLACK	7300BB	8057685559325	
170,00gr.	MILITARY GREEN	7300G	8056138181175	
170,00gr.	WHITE	SN050	8056138182790	

MORPHEUS MID

NEW
ARRIVAL

- Ottimo campo visivo, telaio bioculare ribassato centralmente
- Naso preformato 3D comfort
- Fibbia regolabile con fissaggio micrometrico del cinturino
- Vetro temperato ultra resistente
- Facciale in silicone anallergico
- Design e Technical Concept made in Salvimar

- Two lenses mask, lower frame enlarging the visual field
- 3D comfort nose
- Micrometrically adjustabe strap
- Tempered highly resistant glass
- Hypoallergenic silicon skirt
- Design and technical concept made in Salvimar



SHINING BLUE / BLACK

▶ Suggested Pack: 12 pz

WEIGHT	COLOR	COD.	EAN	€
96,00gr.	BLACK	SN080	8056138189065	
96,00gr.	SHINNING BLUE	SN081	8056138189072	

ENDLESS



- Maschera a vetro portante
- Ridotto volume interno
- Naso preformato 3D comfort
- Fibbia regolabile con fissaggio micrometrico del cinturino
- Vetro temperato ultra resistente
- Facciale in silicone anallergico
- Design e Technical Concept made in Salvimar

- Bearing glass mask
- Low inside volume
- 3D comfort nose
- Micrometrically adjustabe strap
- Tempered highly resistant glass
- Hypoallergenic silicon skirt
- Design and technical concept made in Salvimar



WHITE



PINK

▶ Suggested Pack: 12 pz

WEIGHT	COLOR	COD.	EAN	€
160,00gr.	BLACK	7200BB	8057685557321	
160,00gr.	WHITE	SN060	8056138182813	
160,00gr.	PINK	SN061	8056138182820	

GOBLIN



- Maschera realizzata con tecnologia MonoShell: costampaggio a 2 fasi di lenti, telaio in nylon e facciale in silicone
- Scelta dei materiali di alta qualità: silicone anallergico, vetro temperato 3mm, nylon caricato vetro
- Struttura portante studiata per avvicinare le lenti all'orbita oculare, per ampliare il campo visivo periferico
- Maschera a volume ridotto
- Profilo del facciale studiato per aumentare l'idrodinamicità
- Compensazione agevolata grazie all'ergonomia del naso, grip ergonomico per agevolare la presa delle dita
- Cinghiolo regolabile tramite fissaggio millimetrico della fibbia
- La parte posteriore del cinghiolo è maggiorata per consentire alla maschera un'ottima tenuta
- Il Cinghiolo è dotato di un'apertura posteriore che permette il fissaggio del boccaglio riducendo le vibrazioni durante discesa e risalita
- Mask made with MonoShell technology: 2-phase co-molding of lenses, nylon frame and silicone facepiece
- Choice of high-quality materials: hypo-allergenic silicone, 3mm tempered glass, glass-filled nylon
- Carrier frame designed to bring the lenses closer to the eye socket, to widen the peripheral field of vision
- Low volume mask
- Facepiece profile designed to increase hydrodynamics
- Compensation facilitated by ergonomically designed nose, ergonomic grip to facilitate finger grip
- Adjustable strap by millimetric fixing of the buckle
- The rear part of the strap is enlarged to enable the mask to have a good seal
- The strap has a rear opening that allows the mouthpiece to be fixed, reducing vibrations during descent and ascent

► Suggested Pack: 12 pz

WEIGHT	COLOR	COD.	EAN	€
160 gr	BLACK	7600B	8056138186934	



ANTIAPPANNANTE

- Antiappannante
- Antifog

► Suggested Pack: 15 pz

ml.	COD.	EAN	€
30	400265	8055960725830	

LACCIO SILICONE MASCHERA LUCIDO



- Cinturino in silicone lucido, compatibile con tutte le maschere Salvimar
- Massima elasticità, avvolgente e confortevole

- Mask strap in shiny silicone, suitable for all Salvimar Masks
- Maximum elasticity, wrap-around and comfortable

COLOR	COD.	EAN	€
BLACK	7000L	8058093686467	
WHITE	7000LW	8056138188877	
TRANSPARENT	7000LT	8056138188884	

LACCIO SILICONE MASCHERA OPACO



- Cinturino in silicone lucido, compatibile con tutte le maschere Salvimar
- Massima elasticità, avvolgente e confortevole
- Design made in Salvimar

- Mask strap in shiny silicone, suitable for all Salvimar Masks
- Maximum elasticity, wrap-around and comfortable
- Salvimar exclusive design

COLOR	COD.	EAN	€
BLACK	7800L	8056138181199	
SHINNING BLUE	7800LS	8056138188532	

BITE AIR



SHINNING BLUE



MILITARY GREEN



BLACK



WHITE

- Snorkel extrasoft
- Morso anatomico in silicone anallergico per un prolungato utilizzo
- Passante fissa tubo regolabile in altezza
- Design made in Salvimar

- Extra soft snorkel
- Anatomic mouthpiece in silicone antiallergic for prolonged use
- Adjustable height snorkel keeper
- Salvimar exclusive design

► Suggested Pack: 12 pz

COLOR	COD.	EAN	€
PETROL	700300P	8056138183728	
SHINNING BLUE	700300SB	8056138188334	
MILITARY GREEN	700300G	8057685559356	
BLACK	700300B	8057685559349	
WHITE	700300W	8058093680502	

ELLIPSIS



KRYPSIS CAMU



MILITARY GREEN

- Snorkel con morso preformato in silicone anallergico
- Tubo in PVC morbido di forma ellittica studiata per aumentare l'afflusso d'aria, grazie alla forma curva rimane perfettamente aderente alla testa
- La lunghezza del tubo consente la respirazione anche con mare formato
- Lo snorkel Ellipsis puo esser posizionato a piacimento sul lato della testa preferito, trovata la posizione corretta l'attrito tra le due parti evita che possa spostarsi

- Snorkel a preformed mouthpiece in hypoallergenic
- Tube in soft PVC with elliptical shape, designed to increase the airflow, thanks to its curved shape it remains perfectly adherent to the head
- The length of the tube allows breathing even in rough seas
- The Ellipses snorkel can be positioned at will on the preferred side of the head, once the correct position has been found the friction between the two parts prevents it from moving

► Suggested Pack: 12 pz

COLOR	COD.	EAN	€
BLACK	700400B	8056138180277	
MILITARY GREEN	700400G	8056138180253	
KRYPSIS CAMU	700400K	8056138180970	

TIME



- Snorkel flessibile con tubo morbido
- Morso in silicone anallergico
- Passante fissa tubo regolabile in altezza

- Flexible snorkel with soft tube
- Hypoallergenic silicone mouthpiece
- Adjustable fixing loop

► Suggested Pack: 12 pz

COLOR	COD.	EAN	€
BLACK	700200B	8057685556928	



KNIVES



Photos by Alberto Balbi

KNIVES DISPLAY

**Espositore coltelli da banco, SALVIMAR spearfishing**

- Made in Italy
- **Comprensivo della gamma coltelli Salvimar, 1 per colore:**
 - n° 2 ARES knives
 - n° 3 GOEMON knives
 - n° 2 ST BLADE 75 knives
 - n° 2 ST-ATLANTIS 100 knives
 - n° 6 PREDATHOR knives

Counter knife display, SALVIMAR spearfishing

- Made in Italy
- **Including the Salvimar knife range, 1 per colour:**
 - n° 2 ARES knives
 - n° 3 GOEMON knives
 - n° 2 ST BLADE 75 knives
 - n° 2 ST-ATLANTIS 100 knives
 - n° 6 PREDATHOR knives

COD.

4001KIT

EAN

8058093688706

€

ARES



Blade thickness 4mm

MILITARY GREEN

- Lama con profilo asimmetrico, realizzato per la corretta sfilettatura del pesce
- Lama realizzata in acciaio speciale anticorrosione
- Impugnatura ergonomica anti scivolo
- Doppia fessura di fissaggio sul fodero per favorire il posizionamento sul polpaccio
- Materiale Nylon caricato vetro 30%
- Ottima resistenza agli urti e alle abrasioni
- Profilo dentellato squamapesce
- Fodero con sede a "V" per facilitare l'inserimento della lama

- Blade with asymmetric profile, designed for correct filleting of fish
- Blade made of anticorrosion steel
- Ergonomic non-slip handle
- Double fastening slit on the scabbard to facilitate positioning on the calf
- Material Nylon, 30% Glass-filled
- Excellent shock and scratch resistance
- Serrated profile to scale the fish
- V-shaped scabbard for easy blade insertion



COLOR	TOTAL LENGTH	BLADE LENGTH	GRINDING LENGTH	COD.	EAN	€
BLACK	22 cm	12	12	400104	8058093686863	
MILITARY GREEN	22 cm	12	12	400104M	8058093686993	

GOEMON



ACID GREEN

BLACK

- Lama a punta rinforzata
- Lama realizzata in acciaio speciale anticorrosione
- Fessura maggiorata scoccia aste
- Materiale Nylon caricato vetro 30%
- Ottima resistenza agli urti e alle abrasioni
- Foro per raddrizzare le aste
- Fodero con sede a "V" per facilitare l'inserimento della lama

- Reinforced tip blade
- Blade made of anticorrosion steel
- Enlarged slot for holding shafts
- Material Nylon, 30% Glass-filled
- Excellent shock and scratch resistance
- Hole to straighten shafts
- V-shaped scabbard for easy blade insertion



COLOR	TOTAL LENGTH	BLADE LENGTH	GRINDING LENGTH	COD.	EAN	€
WHITE	19,5	9,5	7,5	400103W	8058093687761	
BLACK	19,5	9,5	7,5	400103	8058093686849	
ACID GREEN	19,5	9,5	7,5	400103G	8058093686856	

ST-ATLANTIS 100



- Coltello da pesca subacquea
- Lama a stiletto a doppio filo liscio e seghettato (Shark Tooth)
- Foro per raddrizzare le aste
- Tacca scoccia aste sul manico

- Underwater fishing knife
- Stiletto blade with smooth and serrated sharpening (Shark Tooth)
- Hole to straighten shafts
- Notch to hold shafts on the handle bars



BLADE BLACK - MILITARY GREEN



BLADE BLACK - ACID GREEN



MIDNIGHT BLUE



MILITARY GREEN

COLOR	TOTAL LENGTH	BLADE LENGTH	GRINDING LENGTH	COD.	EAN	€
BLADE BLACK - BLACK	193mm	89mm	89mm	400105	8056138183964	
BLADE BLACK - MILITARY GREEN	193mm	89mm	89mm	400105M	8056138183971	
BLADE BLACK - ACID GREEN	193mm	89mm	89mm	400105G	8056138183988	
MILITARY GREEN	193mm	89mm	89mm	400101	8055960726837	
MIDNIGHT BLUE	193mm	89mm	89mm	400101B	8058093685989	

ST-BLADE 75

- Coltello da pesca subacquea
- Lama a stiletto a doppio filo liscio e seghettato (Shark Tooth)
- Foro per raddrizzare le aste
- Fodero con sede a "V" per facilitare l'inserimento della lama

- Underwater fishing knife
- Stiletto blade with smooth and serrated sharpening (Shark Tooth)
- Hole to straighten shafts
- V-shaped scabbard for easy blade insertion



RED



COLOR	TOTAL LENGTH	BLADE LENGTH	GRINDING LENGTH	COD.	EAN	€
BLACK	185mm	89mm	75mm	400100	8055960724772	
RED	185mm	89mm	75mm	400100R	8058093685996	

PREDATHOR



- Coltello molto compatto
- Lunghezza con fodero 16cm
- Adatto all'apnea e al freediving
- Lama in acciaio inox 420 a doppio taglio uno liscio l'altro dentellato
- Sistema di sgancio rapido
- Adatto ad avambraccio, braccio, polpaccio e cintura

- Very compact knife
- Length inclusive scabbard 16cm
- Suitable for freediving and spearfishing
- Blade stainless steel 420 with smooth and serrated sharpening
- Device for easy release
- Designed to be fixed to the arm, the forearm, the belt or the calf



MIDNIGHT BLUE



RED



MILITARY GREEN



WHITE



ORANGE

COLOR	TOTAL LENGTH	BLADE LENGTH	GRINDING LENGTH	COD.	EAN	€
RED - BLACK	160mm	80mm	70mm	400102R	8058093684302	
MIDNIGHT BLUE	160mm	80mm	70mm	400102B	8058093684678	
ACID GREEN	160mm	80mm	70mm	400102G	8057685551626	
MILITARY GREEN - BLACK	160mm	80mm	70mm	400102MG	8058093682216	
WHITE - BLACK	160mm	80mm	70mm	400102W	8058093682230	
ORANGE - BLACK	160mm	80mm	70mm	400102O	8058093682247	
BOX 12 KNIVES (assorted colors)	400102OPACK	8058093687143				

SFILETTATORE



- Materiale lama 3Cr13
- Lunghezza lama: 17cm
- Lama flessibile a spessore differenziato: 2mm - 1mm
- Lunghezza totale 31,5cm
- Ideale per sfilettare le vostre catture

- Blade material: 3Cr13
- Blade length: 17 cm
- Flexible blade with differentiated thickness: 2mm - 1mm
- Total length 31.5cm
- Ideal for filleting your catches

COLOR	TOTAL LENGTH	BLADE LENGTH	COD.	EAN	€
RED / BLACK	31,5 cm	17 cm	400106	8056138183957	

FASCIA ELASTICA KRYPISIS KNIFE HOLDER ELASTIC BAND



- Nuova fascia elastica porta coltello in neoprene KRYPISIS
- Altezza 5 cm
- Lunghezza 40 cm
- Adatta per braccio/polpaccio
- New Knife Elastic Band in Neoprene Krypisis
- Height 50 cm
- Width 40 cm
- Suitable for both arm and calf

COD.	EAN	€
ACNEO0020	8056138181083	

FASCIA ELASTICA KNIFE HOLDER ELASTIC BAND



- Fascia in velcro elastica adatta per braccio/polpaccio
- Altezza 5cm
- Lunghezza 40 cm
- Elastic Velcro band suitable for arm/calf
- Height 5 cm
- Length 40 cm

COD.	EAN	€
400120	8057685556355	

FASCIA ELASTICA KNIFE HOLDER ELASTIC BAND SLIM



- Fascia in velcro elastica adatta per braccio/polpaccio
- Altezza 2,5 cm
- Lunghezza 40 cm
- Elastic Velcro band suitable for arm/calf
- Height 2,5 cm
- Length 40 cm

COD.	EAN	€
400120S	8058093689277	



TAGLIASAGOLA SAVER



- Saver, tagliasagola
- Fodero con aggancio per cintura
- Lama in acciaio inossidabile
- Spessore lama: 1,2mm
- Peso: 30 gr.
- Saver, line cutter
- Scabbard with belt attachment
- Stainless steel blade
- Blade thickness: 1.2 mm
- Weight: 30 gr.

COD.	EAN	€
400250	8055960724826	



F R E E D I V I N G W A T C H

FREEDIVE



- Profondimetro 100 mt.
- Tempo di immersione
- Tempo di superficie
- Temperatura acqua
- Nuovo sensore di profondità dalla più rapida ed accurata lettura, con aggiornamenti ad intervalli ogni 0,5ms
- Memorizzazione dati di immersione
- Impostazione allarme: uno di massima profondità uno di tempo massimo di immersione cinque di profondità intermedia
- Quando in immersione, tutte le altre funzioni sono sospese
- Cinturino maggiorato per una migliore adattabilità

- Depth gauge 100 mt.
- Surface time
- Diving time
- Water temperature
- New depth sensor with the fastest and most accurate reading, with updates at intervals every 0.5ms
- Storage of diving data
- Alarm setting: one for max diving depth one for max diving time Five intermediate depths
- Stop any other function when in dive
- Larger strap for better adaptability



	DIVING DEPTH 100 mt.		100 YEARS CALENDAR		EL BACKLIGHT
	STOPWATCH		100M WATER RESISTANT		FIVE INTERMEDIATE DEPTHS SETTING
	WORLD TIME		TEMPERATURE		BATTERY (CR2032)
	CHIME		COUNTDOWN TIMER		NEW GENERATION OF DEPTH SENSOR
	ALARM				

COLOR	COD.	EAN	€
BLACK	8020	8056138182332	

DEEPER



- Profondimetro 100 mt.
- Tempo di immersione
- Tempo di superficie
- Temperatura acqua
- Memorizzazione dati di immersione
- Impostazione allarme:
 - uno di massima profondità
 - uno di tempo massimo di immersione
 - cinque di profondità intermedia
- Quando in immersione, tutte le altre funzioni sono sospese
- Cinturino maggiorato per una migliore adattabilità
- Design e Technical Concept made in Salvimar

- Depth gauge 100 mt.
- Surface time
- Diving time
- Water temperature
- Storage of diving data
- Alarm setting:
 - one for max diving depth
 - one for max diving time
 - Five intermediate depths
- Larger strap for better adaptability
- Stop any other function when in dive
- Design and technical concept made in Salvimar

- Cinturino mimetismo Kryptonite Salvimar Pattern
- Kryptonite camouflage strap Salvimar Pattern



	DIVING DEPTH 100 mt.		100 YEARS CALENDAR		EL BACKLIGHT
	STOPWATCH		100M WATER RESISTANT		FIVE INTERMEDIATE DEPTHS SETTING
	WORLD TIME		TEMPERATURE		BATTERY (CR2032)
	CHIME		COUNTDOWN TIMER		











COLOR	COD.	EAN	€
BLACK - ACID GREEN	8010	8058093687006	
GREEN CAMO	8010G	8058093687013	

ONE PLUS



- Profondimetro 100 mt.
- Tempo di immersione
- Tempo di superficie
- Temperatura acqua
- Memorizzazione dati di immersione
- Impostazione allarme:
uno di massima profondità
uno di tempo massimo di immersione

- Depth gauge 100 mt.
- Surface time
- Diving time
- Water temperature
- Storage of diving data
- Alarm setting:
one for max diving depth
one for max diving time

	DIVING DEPTH 100 mt.		100 YEARS CALENDAR		EL BACKLIGHT
	STOPWATCH		100M WATER RESISTANT		PACER
	WORLD TIME		TEMPERATURE		BATTERY (CR2032)
	CHIME		COUNTDOWN TIMER		

COLOR	COD.	EAN	€
BLACK	8000P	8058093684708	

RICAMBI OROLOGI / SPARE PARTS WATCH

KIT	COD.	EAN	€
Kit O-RING+ 4pz caseback screws ONEPLUS/DEEPER/FREEDIVE	8000/A	8058093687235	
Kit cinturino + 2 perni ONEPLUS	8000/C	8058093687242	
Kit cinturino + 2 perni DEEPER/ FREEDIVE	8010/C	8056138181120	
Kit cinturino +2 perni DEEPER CAMU	8010G/C	8056138181113	



T O R C H E S



ANTARES

AVAILABLE 2024

NEW
ARRIVAL

- Ricarica USB-C incorporata
- LED: SST40 (Max 1800 Lumen)
- Temperatura di Colore: 6500 K
- Autonomia: 120 min
- Parabola: alluminio con superficie liscia
- Ampiezza del fascio di luce: 16° hot spot
- Trattamento della superficie: anodizzazione
- Batteria: 21700/5000mAh Li-ion
- Protezione in caso di inserimento della batteria con polarità invertita
- Impermeabilità IPX8: fino a - 60 metri
- Dimensioni: 172 mm (lunghezza) x 42,5 mm (Ø max testata-torcia).
- Peso netto: circa 263 g. (senza batteria)

- Built in USB-C charger
- LED: SST40 (Max 1800 lumens)
- Color temperature: 6500 K
- Runtime: 120 min
- Reflector: glossy aluminum reflector
- Angle of light beam: 16° hot spot
- Surface treatment: premium anodizing
- Battery: 21700/5000mAh Li-ion
- With battery over-discharging protection, polarity reversing protection
- Waterproof: IPX8 60 Meters underwater
- Dimensions: 172 mm (length) * 42,5 mm (Ø of lamp head)
- Net weight: approx. 263 g. (without battery)

LENGHT	WEIGHT	WATERTIGHT	LED	LUMINOUS FLUX	COLOR TEMPERATURE	BATTERIES	BURNING LIFE
172mm	263gr.	- 100mt	SST40	1800LM	6000K	21700 Lithium-ion	120 min
COLOR		COD.		EAN		€	
BLACK		TOR040		8056138188327			

GALACTIKA

CLICK
HERE

- Ricarica a connessione magnetica
- LED SST40 1500 Lumen
- Ampiezza del fascio di luce: 11° hot spot
- Autonomia: 140 min
- Tempo di ricarica: 5h
- Batteria: 1 x 21700 lioni litio integrata non sostituibile.
- Impermeabilità: IPX8 fino a -100 metri
- Dimensioni: diametro 38 x 161 mm
- Peso netto: 196g
- La torcia ha un unico tasto a scorrimento e 2 modalità di utilizzo:
- Scorrimento - accensione torcia a 1500 Lumen
- Scorrimento e tenuta per più di 2 secondi - modalità di emergenza
- La modalità di emergenza consiste nell'accensione intermittente del LED posto nella parte posteriore della torcia
- Led luminoso verde, carica 100%
- Ricarica a connessione magnetica
- **Per i cicli di carica/scarica della batteria GALACTIKA, il totale dei cicli è superiore a 1000 volte**

- Built-in magnet USB charger
- LED SST40 1500 Lumen
- Angle of light beam: 11° hot spot
- Runtime: 140 min
- Charging time: 5h
- Battery: 1 x 21700 Li - Ion, not removable by the user
- Waterproof: IPX8 -100 meters underwater
- Dimensions: diameter 38 x 161 mm
- Net weight: 196g
- The flashlight has a single slide button and 2 modes of use:
- Sliding - the flashlight turns on at 1500 Lumen
- Sliding for more than 2 sec - emergency mode
- The emergency mode means of intermittent turning on the LED in the backpart of the flashlight
- Green LED on, 100% charge
- Built-i magnet USB charger
- **For cycles of charging / discharging of GALACTIKA battery, it is total cycle times more than 1000 times**

LENGHT	WEIGHT	WATERTIGHT	LUMINOUS FLUX	COLOR TEMPERATURE	BATTERIES	BURNING LIFE
161mm	196gr	-100 m	1500 LM	6500K	n°1 x 21700 Li - Ion	140 min
COLOR		COD.		EAN		€
GREEN - BLACK		TOR010		8056138182004		

FIRELED



- Parabola
- Caricabatterie incluso

- Lens
- Battery charger included

- LED CREE XM-L2 U2 (temperatura colore: 6500 K)
- Livello max. luminosità: 1800 Lumens
- Autonomia: 150 min
- Parabola: alluminio con superficie liscia
- Lente: 4 mm in vetro temperato
- Ampiezza fascio di Luce: 8° hot spot
- Trattamento superficie: Anodizzazione Premium aggiuntiva
- Batteria: n°1 batteria 26650 Lithium-ion ricaricabile (4000 mAh, 3,7 V)
- Protezione contro lo scarico eccessivo della batteria e l'inversione di polarità
- Operatività di voltaggio 4.2 V a 2.8 V
- Profondità operativa : fino a -100 metri
- Dimensioni 157mm (Lunghezza) * 45 mm (diametro max. della testa) * 36 mm (diametro del corpo torcia)
- Peso Netto: ~ 269 gr. (senza Batteria) - Peso Lordo: ~ 362 gr. (con Batteria)
- Peso in immersione: ~ 181 gr. (Con Batteria)

- LED XM-L2 U2 (color temperature: 6500 K)
- Max brightness level: 1800 lumens
- Runtime: 150 min
- Reflector: glossy aluminum reflector
- Lens: 4 mm toughened glass
- Angle of light beam: 8° hot spot
- Surface treatment: premium anodizing
- Battery: 26650 rechargeable Lithium-ion *1 (4000 mAh, 3,7 V)
- With battery over-discharging protection, polarity reversing protection
- Operation voltage: 4.2 V to 2.8 V
- Waterproof: up to 100 Meters
- Dimensions: 157 mm (length) * 45 mm (dia. of lamp head) * 36 mm (dia of lamp body)
- Net weight: ~ 269 g. (without battery)- Gross weight: ~ 362 g. (with battery)
- Underwater weight: ~ 181 g. (with battery)

LENGHT	WEIGHT	WATERTIGHT	LUMINOUS FLUX	COLOR TEMPERATURE	BATTERIES	BURNING LIFE
157mm	269gr	-100 m	1800 LM	6500K	n° 1 26650 Li-ion	150 min
COLOR		COD.		EAN		€
BLACK		400040		8058093683978		

FIRELED USB

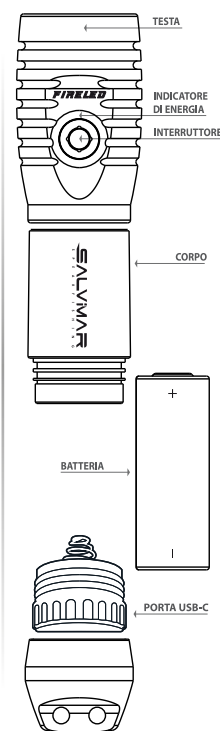

- Ricarica USB-C incorporata
- LED XM-L2 U2 (Max 1800 Lumens)
- Temperatura Colore: 6500 K
- Autonomia: 150 min
- Parabola: alluminio con superficie liscia
- Lente: 4 mm in vetro temperato
- Ampiezza del fascio di luce: 8° hot spot
- Trattamento superficiale: anodizzazione premium aggiuntiva
- Batteria: 26650 Lithium-ion* 1 Ricaricabile - (4000 mAh , 3,7 V)
- Protezione contro lo scarico eccessivo della batteria, protezione in caso di polarità opposta
- Operatività di voltaggio: da 4.2 V a 2.8 V
- Profondità operativa: fino a -100 metri
- Dimensioni: 157 mm (lunghezza) * 45 mm (diametro max testata-torcia) * 36 mm (diametro del corpo torcia)
- Peso netto: circa 269 g. (senza batteria)
- Peso lordo: circa 362 g. (con batteria)
- Peso sott'acqua: circa 181 g. (con batteria)

- Built-in USB-C charger
- LED XM-L2 U2 (Max 1800 Lumens)
- Color temperature: 6500 K
- Runtime: 150 min
- Reflector: glossy aluminum reflector
- Lens: 4 mm toughened glass
- Angle of light beam: 8° hot spot
- Surface treatment: premium anodizing
- Battery: 26650 lithium-ion battery * 1 - (4000 mAh , 3,7 V)
- With battery over-discharging protection, polarity reversing protection
- Operation voltage: 4.2 V to 2.8 V
- Waterproof: up to 100 Meters
- Dimensions: 157 mm (length) * 45 mm (dia. of lamp head) * 36 mm (dia. of lamp body)
- Net weight: approx. 269 g. (without battery)
- Gross weight: approx. 362 g. (with battery)
- Underwater weight: approx. 181 g. (with battery)

LENGHT	WEIGHT	WATERTIGHT	LUMINOUS FLUX	COLOR TEMPERATURE	BATTERIES	BURNING LIFE
157mm	269gr	-100 m	1800 LM	6500K	n° 1 26650 Li-ion	150 min
COLOR		COD.		EAN		€
GREEN		400070		8056138183322		

LIGHT BLAST / LIGHT BLAST WARM



LIGHT BLAST

LENGHT	WEIGHT	WATERTIGHT	LUMINOUS FLUX	COLOR TEMPERATURE	BATTERIES	BURNING LIFE
158mm	205gr	-60 m	1200 LM	6500K	n° 1 18650 Li-ion	120 min
COLOR		COD.		EAN		€
BLACK		400020		8056138180222		

NEW LIGHT BLAST WARM

LENGHT	WEIGHT	WATERTIGHT	LUMINOUS FLUX	COLOR TEMPERATURE	BATTERIES	BURNING LIFE
158mm	205gr	-60 m	1200 LM		n° 1 18650 Li-ion	120 min
COLOR		COD.		EAN		€
BLACK		400020W		8056138182998		

BLAST X2



- LED XM-L2 U2
- Tempertura colore: 6500 K
- Livello max. luminosità: 1200 Lumens
- Parabola: alluminio con superficie Liscia
- Trattamento superficie: Anodizzazione Premium aggiuntiva
- Protezione contro lo scarico eccessivo della batteria
- Protezione contro l'inversione di polarità
- Operatività di voltaggio 4.2 V a 2.8 V
- Profondità operativa : fino a -60 mteri
34 mm (diametro max. della testa)
- Ricarica USB-C incorporata, con indicatore

- LED XM-L2 U2
- Color temperature: 6500 K
- Max brightness level:1200 lumens
- Reflector: Glossy aluminum reflector
- Surface treatment: Additional premium anodizing
- Battery over-discharging protection
- Polarity reversing protection
- Operation voltage 4.2 V to 2.8 V
- Waterproof up to 60 meters
- Dimensions: 165mm (Length) * 34mm (head max diameter)
- Integrated USB-C recharge, with indicator

LENGHT	WEIGHT	WATERTIGHT	LUMINOUS FLUX	COLOR TEMPERATURE	BATTERIES	BURNING LIFE
225mm	220gr	-60	1200 LM	6500K	n° 1 37300 Li-ion	240 min
COLOR		COD.		EAN		€
BLACK		400025		8056138181540		

SPOTLIGHT



- LED XP-G2 R5 (Max 400 Lumens)
- Temperatura Colore: 6500 K
- Autonomia: 120 min
- Parabola: alluminio con superficie liscia
- Lente: 4 mm in vetro temperato
- Ampiezza del fascio di luce: 8° hot spot
- Trattamento della superficie: anodizzazione premium aggiuntiva
- Batteria: AAA x 3
- Protezione dall'inversione di polarità
- Range di voltaggio: da 4.5 V a 2.7 V
- Profondità operativa: fino a - 100 metri
- Dimensioni: 130 mm (lunghezza) * 40 mm (diametro max della testa) * 30 mm (diametro del corpo)
- Peso netto: circa 200 g. (senza batterie)
- Peso lordo: circa 234 g. (con batterie)
- Peso sott'acqua: circa 130 g. (con batterie)
- Batterie non fornite di serie

- LED XP-G2 R5 (Max 400 Lumens)
- Color temperature: 6500 K
- Runtime: 120 min
- Reflector: glossy aluminum reflector
- Lens: 4 mm toughened glass
- Angle of light beam: 8° hot spot
- Surface treatment: premium anodizing
- Battery: AAA battery * 3
- With battery polarity reversing protection
- Operation voltage: 4.5 V to 2.7 V
- Waterproof: up to 100 Meters
- Dimensions: 130 mm (length) * 40 mm (dia. of lamp head) * 30 mm (dia. of lamp body)
- Net weight: approx. 200 g. (without batteries)
- Gross weight: approx. 234 g. (with batteries)
- Underwater weight: approx. 121 g. (with batteries)
- Batteries not supplied as standard

- Indicatore di carica e interruttore
- Power light and switch

LENGHT	WEIGHT	WATERTIGHT	LUMINOUS FLUX	COLOR TEMPERATURE	BATTERIES	BURNING LIFE
130mm	200 g	-100 m	400 LM	6500 K	AAA x 3	120 min
COLOR	COD.		EAN		€	
BLACK	400030		8058093683763			

LECOLED



- Potente e compatta torcia
- Ideale per la pesca subacquea
- Corpo in policarbonato
- Ghiera di dissipazione in alluminio
- Parabola in materiale sintetico anti ossidazione
- Utilizza un singolo CREE led Q5 da 3w, in grado di sprigionare 340 lumen (circa 7000 lux ad 1 m)
- Fascio concentrato(XR-E led size) a temperatura colore di 6000K
- Alimentazione con 4 batterie AA da 1,5V o AA ricaricabili (2700mAh)
- Autonomia 5 ore, equivalente a 17 ore con accensioni intermittenti* (60 sec on, 180 sec off)
- Subacquea fino a 50m
- Accensione magnetica
- * L'autonomia e le prestazioni possono variare in funzione delle batterie utilizzate
- Interruttore **Made in Italy** - Progetto esclusivo Salvimar
- Batterie non fornite di serie

- Powerful and compact dive light
- Ideal for spearfishing
- Polycarbonate body
- Aluminum ring dissipator
- Synthetic anti-oxidation reflector parabola
- Use a single CREE 3W Q5 LED, able to release 340 lumens (about 7000 lux at 1 m)
- Concentrated beam (XR-E LED size) with a color temperature of 6000K
- Powered by 4 1.5 V AA batteries or AA rechargeable batteries (2700mAh)
- Autonomy 5 hours or up to 17 hours with intermittent switching (60 sec on, 180 sec off)
- Watertight up to 50 m
- Magnetic switch
- * Autonomy and performances can vary depending on the batteries used
- **Made in Italy** switch - Proyecto esclusivo Salvimar
- Batteries not supplied as standard

- CREE led Q5 da 3w - dissipatore in alluminio
- CREE 3W Q5 LED - aluminum dissipator

LENGHT	WEIGHT	WATERTIGHT	LED	LUMINOUS FLUX	COLOR TEMPERATURE	BATTERIES	BURNING LIFE
160mm/6.3inch	230gr.	- 50mt	high power 3W CREE	340LM	6000K	4 x AA 1.5V	5 - 17h*
COLOR	COD.		EAN		€		
BLACK	400000		8055960726851				

RIGEL



- n° 3 LED XM-L2 U2
- Temperatura colore: 6500 K
- Livello max. luminosità: 3800 Lumens
- Autonomia: 250 min
- Parabola: alluminio con superficie liscia
- Trattamento superficie: Anodizzazione Premium aggiuntiva
- Batteria: n°2 batterie 26650 Lithium-ion ricaricabile (4000 mAh, 3,7 V)
- Protezione contro lo scarico eccessivo della batteria
- Protezione contro l'inversione di polarità
- Operatività di voltaggio 4.2 V a 2.8 V
- Profondità operativa : fino a -100 metri
- Dimensioni 255mm (Lunghezza) * 60 mm (diametro max. della testa)
- Peso Netto: circa 580 gr. (senza Batteria)
- Ricarica USB-C incorporata, con indicatore

- n° 3 LED XM-L2 U2
- Color temperature: 6500 K
- Max brightness level: 3800 Lumens
- Runtime: 250 min
- Reflector: Glossy aluminum reflector
- Surface treatment: Additional premium anodizing
- Battery: n°2 rechargeable batteries 26650 Lithium-ion (4000 mAh, 3,7 V)
- Battery over-discharging protection
- Polarity reversing protection
- Operation voltage 4.2 V to 2.8 V
- Waterproof up to 100 meters
- Dimensions: 255mm (Length) * 60 mm (head max diameter)
- Net weight: 580 gr. (without battery)
- Integrated USB-C recharge, with indicator

LENGHT	WEIGHT	WATERTIGHT	LUMINOUS FLUX	COLOR TEMPERATURE	BATTERIES	BURNING LIFE
255mm	580gr	-100 m	3800 LM	6500K	n°2 26650 Li-ion	250 min
COLOR		COD.		EAN		€
BLACK		400060		8056138180499		

MIZAR

NEW ARRIVAL

TORCHES

SALVIMAR SPEARFISHING



- Ricarica USB-C incorporata
- LED 3xSST40 - 4200 Lumen
- Autonomia: 250 min
- Batteria: 2 x 26650 Ioni litio/9000mAh
- Impermeabilità: IPX8 fino a - 100 metri
- Dimensioni: 255 mm x 73 mm
- Peso netto: 710 g.
- La torcia ha 4 modalità di utilizzo :
Prima pressione - 2200 Lumen
Seconda pressione - 660 Lumen
Terza pressione: modalità S.O.S.
- Tenendo premuto per più di 2 secondi - 4200 Lumen (dopo 8 minuti passa automaticamente a 2200 Lumen per evitare l'eccessivo surriscaldamento)

- Built-in USB-C charger
- LED 3xSST40 - 4200 Lumen
- Runtime: 250 min
- Battery: 2 x 26650 Ioni litio/9000mAh
- Waterproof: IPX8 -100 meters underwater
- Dimensions: 255 mm x 73 mm
- Net weight: 710 g.
- The lamp has 4 different brightness modes:
- First press of the switch button -2200lumen
- Second press of the switch button -660lumen
- Third press of the switch button: S.O.S. mode
- Keeping pressed the switch button above 2 seconds - 4200 lumen (after 8 minutes it will be automatic change to 2200lumen to avoid the overheating)

LENGHT	WEIGHT	WATERTIGHT	LED	LUMINOUS FLUX	COLOR TEMPERATURE	BATTERIES	BURNING LIFE
225mm/8.8inch	710gr.	- 100mt	CREE 3xSST40	4200LM	6000K	2 x 26650 Ioni litio	250 min
COLOR		COD.		EAN		€	
BLACK		TOR020		8056138186262			

FOCUS

NEW
ARRIVAL

- Ricarica USB-C incorporata
- LED XHP50 (Max 3000 Lumens)
- Temperatura Colore: 6500 K
- Autonomia: 180 min
- Parabola: alluminio con superficie liscia
- Lente: 4 mm in vetro temperato
- Ampiezza del fascio di luce: regolabile 11° ~ 73°
- Trattamento superficiale: anodizzazione premium aggiuntiva
- Batteria: 26650 Lithium-ion* 1 Ricaricabile - (5000 mAh , 3,7 V)
- Protezione contro lo scarico eccessivo della batteria, protezione in caso di polarità opposta
- Operatività di voltaggio: da 4.2 V a 2.8 V
- Profondità operativa: fino a -100 metri
- Dimensioni:
 - 202 mm (lunghezza)
 - 54 mm (diametro max testata-torcia)
 - 36 mm (diametro del corpo torcia)
- Peso netto: circa 446 g. (senza batteria)
- Peso lordo: circa 545 g. (con batteria)

- Built-in USB-C charger
- LED XHP50 (Max 3800 Lumens)
- Color temperature: 6500 K
- Runtime: 180 min
- Reflector: glossy aluminum reflector
- Lens: 4 mm toughened glass
- Angle of light beam: adjustable 11° ~ 73°
- Surface treatment: premium anodizing
- Battery: 26650 lithium-ion battery * 1 - (5000 mAh , 3,7 V)
- With battery over-discharging protection, polarity reversing protection
- Operation voltage: 4.2 V to 2.8 V
- Waterproof: up to 100 Meters
- Dimensions:
 - 202mm (length)
 - 54mm (dia. of lamp head)
 - 36 mm (dia. of lamp body)
- Net weight: approx. 446g. (without battery)
- Gross weight: approx. 545g. (with battery)

LENGHT	WEIGHT	WATERTIGHT	LED	LUMINOUS FLUX	COLOR TEMPERATURE	BATTERIES	BURNING LIFE
202mm/7.9inch	446gr.	- 100mt	high power 3W CREE	3000LM	6000K	26650 Lithium-ion	180 min
COLOR		COD.		EAN		€	
BLACK		TOR030		8056138186279			

RICAMBI TORCE / SPARE PARTS TORCHES

SPARE PARTS	COD.	EAN	€
Corpo plastica Torcia LECOLED	400000/A	8057685559691	
ELETRONIC SYSTEM/corpo led Torcia LECOLED	400000/C	8057685559714	
Testa alluminio Torcia LECOLED	400000/D	8057685559721	
Interruttore Verde Torcia LECOLED	400000/FG	8056138188570	
Batteria per torcia DAYLIGHT / BLAST LIGHT	400010/A	8056138182455	
Carica Batteria per Torcia DAYLIGHT / BLAST LIGHT	400010/B	8056138181366	
Batteria (2x18650) per Torcia BLASTX2	400025/A	8056138186859	
Batteria per Torcia FIRELED / FOCUS	400040/A	8058093684333	
Carica Batteria per Torcia FIRELED / FOCUS	400040/B	8058093684340	
Batteria (2x26650) per RIGEL / MIZAR	400060/A	8056138181601	
Cavo magnetico Connessione GALACTIKA	ACTOR010	8056138185395	
Batteria per torcia ANTARES	TOR040/A	8056138188563	



A C C E S S O R I E S





KIT MONO

KIT Sagole MONO composto da:

- n° 16 rocchetti di sagola da 50 mt
- Ø1,00mm - Ø1,20mm - Ø1,50mm - 1,80mm
- Colori: Rosso - Arancione - Acid Green - Blu
- Espositore in cartonato

MONO Lines KIT consisting of:

- 16 reels of 50m line
- Ø1.00mm - Ø1.20mm - Ø1.50mm - 1.80mm
- Colours: Red - Orange - Acid Green - Blue
- Cardboard display

COD	COD.	EAN	€
KIT40037	50mt x16pz +espositore		



SAGOLA MONO

- La sagola SAGOLA MONO è stata progettata per essere un'unica linea tra mulinello e asta, eliminando l'utilizzo del terminale di collegamento
- Mantiene invariato il carico di rottura fino all'asta
- Anima interna in HMPE ad alto modulo polietilene
- Calza esterna in HMPE rivestita in PU (Poliuretano)
- Il rivestimento in PU impedisce la formazione delle "cocche"
- Altissima resistenza all'usura e all'abrasione
- Elevato carico di rottura
- Resistente ai raggi UV
- Galleggiante

- The SAGOLA MONO line has been designed to be a single line between reel and shaft, eliminating the use of the connection end
- Keeps the breaking load unchanged up to the shaft
- High modulus polyethylene HMPE inner core
- PU (Polyurethane) coated HMPE outer liner
- The PU coating prevents the formation of "kinks"
- Very high wear and abrasion resistance
- High breaking strength
- UV resistant
- Buoyant

BLUE | 50m

ORANGE | 50m

ACID GREEN | 50m - 100m

RED | 50m - 100m - 400m



MONO 1,00mm

DIAMETER	ULTIMATES STRENGTH	LENGHT	COLOR	COD.	EAN	€
1,00mm	150kg	50m	Blue	400370B	8056138181762	
1,00mm	150kg	50m	Orange	400370O	8056138181724	
1,00mm	150kg	50m	Acid Green	400370G	8056138181649	
1,00mm	150kg	100m	Acid Green	400370G/100	8056138181687	
1,00mm	150kg	50m	Red	400370	8056138180659	
1,00mm	150kg	100m	Red	400370/100	8056138181267	
1,00mm	150kg	400m	Red	400370/400	8056138180666	

MONO 1,20mm

DIAMETER	LENGHT	COLOR	COD.	EAN	€
1,20mm	50m	Blue	400372B	8056138181779	
1,20mm	50m	Orange	400372O	8056138181731	
1,20mm	50m	Acid Green	400372G	8056138181656	
1,20mm	100m	Acid Green	400372G/100	8056138181694	
1,20mm	50m	Red	400372	8058093688751	
1,20mm	100m	Red	400372/100	8056138181236	
1,20mm	400m	Red	400372/400	8056138180673	

MONO 1,50mm

DIAMETER	LENGHT	COLOR	COD.	EAN	€
1,50mm	50m	Blue	400375B	8056138181786	
1,50mm	50m	Orange	400375O	8056138181748	
1,50mm	50m	Acid Green	400375G	8056138181663	
1,50mm	100m	Acid Green	400375G/100	8056138181700	
1,50mm	50m	Red	400375	8058093688768	
1,50mm	100m	Red	400375/100	8056138181243	

MONO 1,80mm

DIAMETER	LENGHT	COLOR	COD.	EAN	€
1,80mm	50m	Blue	400378B	8056138181793	
1,80mm	50m	Orange	400378O	8056138181755	
1,80mm	50m	Acid Green	400378G	8056138181670	
1,80mm	100m	Acid Green	400378G/100	8056138181717	
1,80mm	50m	Red	400378	8058093688775	
1,80mm	100m	Red	400378/100	8056138181250	

CYMAX (CLIMAX® Material)



Package in 50 m reels,
until 100 m in continuous

- Rapporto di rottura/diametro elevatissimo
- Resistente ai raggi UV
- Sagola galleggiante resistente all'usura dell'acqua di mare
- Very high tensile strength/diameter ratio
- UV resistant
- Floating line resistant to sea water wear

DIAMETER	ULTIMATES STRENGHT	LENGHT	COD.	EAN	€
Ø1,05 mm	155kg	50m	400316	8055960724895	
Ø1,25 mm	210kg	50m	400317	8055960724901	
Ø1,70 mm	350kg	50m	400320	8055960724918	

ACIDYNE

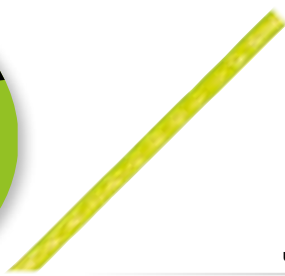
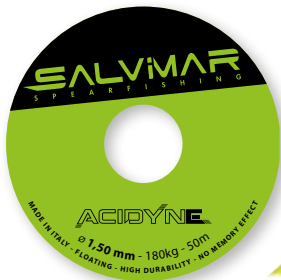

Package in 50 m reels,
until 100 m in continuous



Package in 400 m

- Rapporto carico di rottura/diametro elevatissimo
- Nuova colorazione Acid Green per favorire la visibilità
- Resistente ai raggi UV
- Sagola resistente all'usura dell'acqua di mare
- Very high tensile strength/diameter ratio
- New Acid Green colour for better visibility
- UV resistant
- Line resistant to sea water wear

DIAMETER	ULTIMATES STRENGHT	LENGHT	COD.	EAN	€
Ø1,3 mm	140kg	50m	400335	8057685557383	
Ø1,3 mm	140kg	400m	400335/400	8058093689574	
Ø1,5 mm	180kg	50m	400340	8058093682155	

DYNEEMA



Package in 50 m reels,
until 100 m in continuous



Package in 400 m

- Anima in Dyneema® SK75
- Copertura in poliestere rigida
- Resistente ai raggi UV
- Sagola resistente all'usura dell'acqua di mare
- Core in Dyneema® SK75
- Rigid polyester cover
- UV resistant
- Line resistant to sea water wear

DIAMETER	COLOR	ULTIMATES STRENGHT	LENGHT	COD.	EAN	€
Ø1,5mm	GREEN-BLACK	120kg	5m	400361	8056138180734	
Ø1,5mm	GREEN-BLACK	120kg	50m	400360	8058093684494	
Ø1,5mm	BLACK	120kg	50m	400360/B	8058093689093	
Ø1,5mm	GREEN-BLACK	120kg	400m	400323/400G	8058093689314	
Ø1,5mm	BLACK	120kg	400m	400323/400B	8058093689307	
Ø2,0mm	GREEN-BLACK	240kg	5m	400365	8058093684500	
Ø2,0mm	GREEN-BLACK	240kg	50m	400345	8058093689109	
Ø2,0mm	BLACK	240kg	50m	400345/B	8058093689116	
Ø2,0mm	GREEN-BLACK	240kg	400m	400326/400G	8058093689338	
Ø2,0mm	BLACK	240kg	400m	400326/400B	8058093689321	

POLYESTER



Package in 50 m reels,
until 100 m in continuous



Package in 400 m

- Ideale per legature elastiche
- Resistente ai raggi UV
- Sagola resistente all'usura dell'acqua di mare
- Ideal for binding rubbers
- UV resistant
- Line resistant to sea water wear

DIAMETER	COLOR	ULTIMATES STRENGHT	LENGHT	COD.	EAN	€
Ø1,7mm	BLACK-GREEN	90kg	50m	400333	8058093689123	
Ø1,7mm	BLACK-GREEN	90Kg	400m	400330/400	8058093689567	
Ø1,7mm	ACID GREEN	90Kg	50m	400333/G	8058093689130	
Ø1,7mm	ACID GREEN	90Kg	400m	400330/400G	8058093689550	

PINZA SLEEVES

- Pinza serra sleeve in acciaio con impugnatura in gomma coostampata
- Fori dimensionati al serraggio degli sleeve sul monofilo dedicato
- Taglia sagola laterale
- Perno scorrevole di serraggio a riposo

- Steel sleeve clamping pliers with co-molded rubber grip
- Holes sized to the sleeve clamping on the dedicated monofilament
- Side line cutter
- Sliding clamping pin in rest position

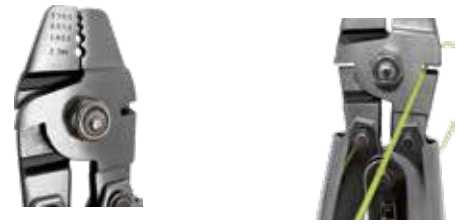

COD.

ACC0010

EAN

8056138181991

€

NYLON



- Terminale monofilo Nylon, morbido trasparente Ø1,50mm, rotolo da 2Kg
- In versione colore trasparente e acid green ad alta visibilità

- Nylon monofilament, soft transparent Ø1.50mm, 2kg reel
- Transparent colour inversion and high visibility acid green

DIAMETER

COLOR

COD.

LENGHT

EAN

€

Ø1,5mm

TRANSPARENT

L11CAV04

766mt

8056138182967

Ø1,6mm

ACID GREEN

L11CAV05

766mt

8058093683138



- Monofilo ad alta visibilità.
- Acid Green. Ø1,5mm - lenght 15mt

- High visibility monofilament.
- Acid Green. Ø1,5mm - lenght 15mt

DIAMETER

COD.

LENGHT

EAN

€

Ø1,5mm

400352

15mt

8058093682179

Ø2,0mm

400353

15mt

8058093689369



- Monofilo Nylon ad alta resistenza Ø1,47mm - lenght 6mt
- Carico di rottura elevatissimo Kg 151 - Lb 332,8
- Massima resistenza all'abrasione

- Nylon line, high strength Ø1,47mm - lenght 6mt
- High ultimate strength Kg 151 - Lb 332,8
- Hight resistance to scraping

COD.

400355

LENGHT

6m

EAN

8057685557796

€



- Terminale monofilo Nylon, morbido trasparente Ø1,50mm - lenght 6m

- Nylon line, transparent soft Ø1,50mm - lenght 6mt

COD.

400350

LENGHT

6mt

EAN

8057685557789

€

MARSIGLIESE PRO



- Cintura elastica marsigliese con fibbia inox, fori rinforzati e inserimento piombi facilitato
- Spessore differenziato
- Gomma naturale
- "Design" e "concept" made in Salvimar

- Marseillaise elastic weight belt with stainless steel buckle, reinforced holes and easy weight insertion
- Differentiated thickness
- Natural rubber
- "Design" and "concept" made in Salvimar



BLUE

► Suggested Pack: 20 pz

COLOR	LENGHT	COD.	EAN	€
BLACK	135cm	400050B	8055960726875	
BLACK	155cm	400051B	8055960726882	
BLUE	135cm	000200B	8057685558762	
BLUE	155cm	000200A	8057685557765	

MARSIGLIESE MESH



- Gomma: mesh antiscivolo
- Spessore: 3,6mm
- Lunghezza: 130cm
- Fibbia : acciaio inox con sistema a sgancio rapido
- Interasse fori: 5cm

- Rubber: Non-slip mesh
- Thickness: 3.6 mm
- Length: 130 cm
- Buckle: stainless steel with quick-release system
- Hole spacing: 5 cm

► Suggested Pack: 20 pz

COLOR	LENGHT	COD.	EAN	€
BLACK	130cm	400055B	8056138183889	

ELASTICA PRO



- Cintura piombi elastica con fibbia inox
- Spessore differenziato
- Gomma naturale
- Design e Technical Concept made in Salvimar

- Elastic belt with stainless steel buckle
- Differentiated thickness
- Natural rubber
- Exclusive Salvimar design

► Suggested Pack: 20 pz

BUCKLE	COD.	EAN	€
INOX	400052B	8055960726899	

PIOMBI ELASTICA ECO



- Cintura piombi elastica ECO con fibbia inox
- Gomma naturale

- ECO elastic weight belt with inox buckle
- Natural rubber

► Suggested Pack: 20 pz

BUCKLE	COD.	EAN	€
INOX	AP016	8055960725618	

SNAKE ELASTICA PRO



- Cintura piombi elastica con fibbia nylon
- Spessore differenziato
- Gomma naturale
- Design e Technical Concept made in Salvimar

- Elastic weight belt with nylon buckle
- Differentiated thickness
- Natural rubber
- Exclusive Salvimar design

► Suggested Pack: 20 pz

BUCKLE	COD.	EAN	€
NYLON	400053B	8055960726905	

SNAKE PIOMBI ELASTICA ECO



- Cintura piombi elastica con fibbia nylon
- Spessore differenziato
- Gomma naturale
- Design e Technical Concept made in Salvimar

- ECO elastic weight belt with nylon buckle
- Differentiated thickness
- Natural rubber
- Exclusive Salvimar design

► Suggested Pack: 20 pz

BUCKLE	COD.	EAN	€
NYLON	AP016B	8055960727667	

PIOMBI CORDURA INOX



- Cintura piombi in Cordura con fibbia inox

- Cordura Weight belt with steel buckle



► Suggested Pack: 30 pz

COLOR	BUCKLE	COD.	EAN	€
BLACK	INOX	AP015	8055960725601	
MILITARY GREEN	INOX	AP015M	8058093689963	
RED	INOX	AP015R	8058093689956	
ACID GREEN	INOX	AP015V	8058093689949	

SNAKE PIOMBI CORDURA NYLON



- Cintura piombi in Cordura con fibbia nylon

- Cordura Weight belt with nylon buckle



► Suggested Pack: 30 pz

COLOR	BUCKLE	COD.	EAN	€
BLACK	NYLON	AP017	8055960725625	
MILITARY GREEN	NYLON	AP017M	8058093689994	
RED	NYLON	AP017R	8058093689987	
ACID GREEN	NYLON	AP017V	8058093689970	

FIBBIA INOX



KIT	COD.	EAN	€
1pz	AP010	8055960725595	

FIBBIA SNAKE NYLON



- Nuova fibbia in NYLON caricato 30%
- Passanti cintura maggiorati per ottimizzare la compattezza
- Leva di fissaggio rinaforzata
- Blocca Nylon/Gomma da 1,5 a 4,0mm

- New 30% loaded NYLON buckle
- Oversized belt loops to optimise compactness
- Reinforced fastening lever
- Nylon/Rubber lock from 1.5 to 4.0mm



KIT	COLOR	COD.	EAN	€
6	MILITARY GREEN	AP012/M	8056138184237	
6	BLACK	AP012	8058093689826	
6	ACID GREEN	AP012/G	8056138184251	
6	RED	AP012/R	8056138184244	

WHALE BLACK & WHALE CARBON LOOK



AVAILABLE 2024

Borsone porta attrezzatura con capienza da 135 litri. Realizzato in robusto PVC Tarpaulin saldato ad alta frequenza, giunture stagne. Dotato di valvola per consentire lo scarico dell'acqua dopo aver lavato l'attrezzatura all'interno della borsa. Waterproof, impedisce la fuoriuscita di acqua durante il trasporto. Due maniglie laterali e spallacci a tracolla regolabili e rimovibili. Presente un ampio scomparto a rete interno ed una tasca esterna sulla parte superiore con cerniera resistente all'acqua.

- saldature stagne
- Adatto al trasporto di pinne da apnea
- Ampia apertura ad U
- Tasca esterna water resistant
- Capienza 135 litri
- Base waterproof con valvola di scarico acqua
- Materiale pvc tarpaulin ad alta resistenza all'usura
- Misure 103 x 35 x 38cm

Equipment duffel bag 135 litre capacity. Made of robust, high frequency welded Tarpaulin PVC, watertight seams. Equipped with a valve to allow the water to drain after washing the equipment inside the bag. Waterproof, prevents water escaping during transport. Two side handles and adjustable and removable shoulder straps. It has a large internal mesh compartment and an external pocket on the top with a water-resistant zip.

- Watertight welded seams
- Suitable for carrying freediving fins
- Wide U-shaped opening
- Water-resistant external pocket
- Capacity 135 litres
- Waterproof base with water drain valve
- PVC tarpaulin material with high wear resistance
- Dimensions: 103 x 35 x 38cm



COLOR	CAPACITY	SIZE	COD.	EAN	€
BLACK	135 lt	103 x 35 x 38 cm	BAG02BK	8056138188082	
CARBON LOOK	135 lt	103 x 35 x 38 cm	BAG02C	8056138188075	

SALVIMAR FIN BAG



KRYPSIS CAMU

- Zaino porta pinne lunghe/professionali
- Cerniera semi-perimetrale a doppio cursore
- Cinghie regolabili per trasporto in spalla
- Realizzata in robusto nylon impermeabile antistrappo
- Ampia tasca centrale porta accessori - aperta su 3 lati
- Supporti laterali per fissaggio arbalette o pneumatico
- Spallacci regolabili

- Backpack for long/professional fins
- Half-perimetral double slider zipper
- Adjustable strap for shoulder carriage
- Made in strong watertight nylon
- Wide front pocket over 3 sides
- Adjustable shoulder straps

► Suggested Pack: 5 pz

COLOR	SIZE	COD.	EAN	€
BLACK - ACID GREEN	10 + 15 x 25 x 115 cm	400196	8058093689765	
KRYPSIS CAMU	10 + 15 x 25 x 115 cm	400196K	8058093689758	

ROLLER BIG 100

AVAILABLE 2024

NEW
ARRIVAL

- Capiente borsa porta attrezzatura con ruote e maniglie di trasporto
- Ottimizza gli spostamenti quando impiegata per viaggi ed escursioni
- Realizzata in Strong Tarpaulin, resiste ad ogni tipo di sollecitazione ed uso
- Doppia tasca interna/esterna
- Spallacci per il trasporto manuale
- Apertura U-Zip per facilitarne il pronto impiego

- Large equipment bag with wheels and carrying handles
- Optimizes movements when used for travel and excursions
- Made of Strong Tarpaulin, it resists to any kind of stress and use
- Double inside/outside pocket
- Shoulder straps for hand carriage
- U-Zip opening for easy use

Ruote | Wheels

COLOR	CAPACITY	SIZE	COD.	EAN	€
BLACK	100 lt	44 x 28 x 95 cm	BAG03BK	8056138188549	

SALVIMAR DRY BACK PACK 60/80

NEW ARRIVAL

BAGS

SALVIMAR SPEARFISHING

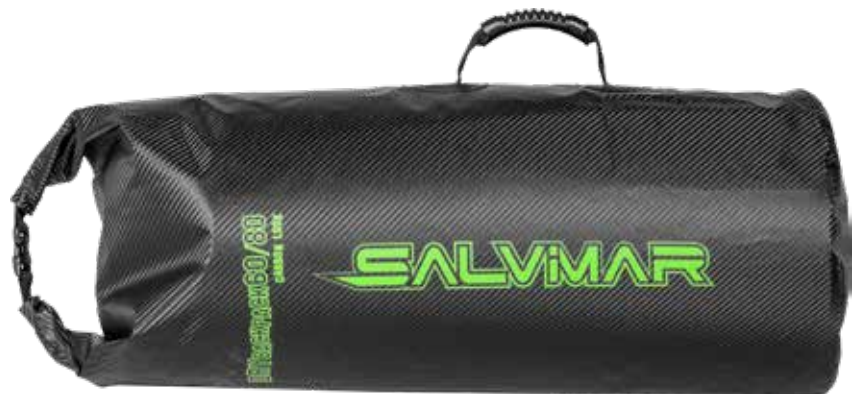
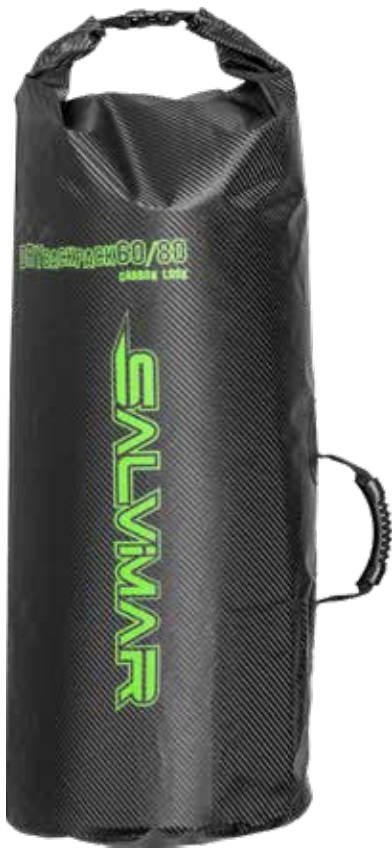

BLACK



ACID GREEN

- Borsone porta attrezzatura a zaino completamente stagno, realizzato in robusto PVC Tarpaulin, chiusura ad arrotolamento e giunture stagne
- Dotato di spallacci imbottiti e removibili, può essere trasportato a mano o in spalla
- Capacità max. 80 litri
- Può ospitare anche un paio di pinne da apnea

- Completely waterproof gear back pak, made of sturdy PVC Tarpaulin, rolling closing and watertight joints
- Equipped with padded shoulder and removable straps, can be carried by hand or shoulder
- Capacity max. 80 liters
- Can also accommodate a pair of freediving fins



► Suggested Pack: 10 pz

	COLOR	CAPACITY	SIZE	COD.	EAN	€
NEW	CARBON LOOK	80 lt	44 x 28 x 75 cm	400204C	8056138184947	
	BLACK	80 lt	44 x 28 x 75 cm	400204	8055960724802	
	ACID GREEN	80 lt	44 x 28 x 75 cm	400204G	8058093686474	

DRY BIG 100

NEW
ARRIVAL

- Capiente borsone porta attrezzatura completamente stagno, realizzato in robusto PVC Tarpaulin, chiusura con cerniera impermeabile
- Giunture stagne e valvola di scarico per l'acqua
- Gli ampi manici consentono di trasportarlo a mano, a tracolla ed in spallao

- Large equipment bag completely watertight, made of sturdy PVC Tarpaulin, waterproof zipper closing
- Watertight joints and drain valve for water
- The long handles allow you to carry by hand, by shoulder and as backpack



► Suggested Pack: 10 pz

COLOR	CAPACITY	SIZE	COD.	EAN	€
CARBON LOOK	100lt	44 x 28 x 95 cm	400202C	8056138184930	

CYCLOPS



- Capiente borsone porta attrezzatura, realizzato in tessuto 420D
- Ripstop, doppia trama, chiusura con cerniera impermeabile
- Gli ampi manici consentono di trasportarlo a mano, a tracolla ed in spalla

- Large equipment bag, made of 420D
- "Ripstop" fabric, double weave, waterproof zipper closing
- The long handles allow you to carry by hand, by shoulder and as backpack

► Suggested Pack: 6 pz

COLOR	CAPACITY	SIZE	COD.	EAN	€
BLACK	100 lt	44 x 28 x 95 cm	400207	8058093683787	

TANTO BAG



- Borsa porta fucili realizzata in robusto PVC Tarpaulin
- Chiusura con cerniera impermeabile, apribile per tutta la lunghezza per trasformarla in tappetino
- Giunture stagne
- Gli ampi spallacci consentono di trasportarla a mano, a tracolla ed in spalla in modo bilanciato
- Oltre i fucili, può ospitare anche un paio di pinne da apnea

- Speargun bag made of strong PVC Tarpaulin
- Waterproof zipper, openable along the length to turn it into the mat
- Watertight joints
- The large shoulder straps allow you to carry by hand, shoulder and as backpack a balanced way
- Besides the guns, can also accommodate a pair of freediving fins

► Suggested Pack: 10 pz

COLOR	SIZE	COD.	EAN	€
BLACK	155 x 35 cm	400200	8055960724789	

TALL BAG



BLACK

- Borsa porta fucili realizzata in tessuto 420D Ripstop
- Chiusura con cerniera
- Ampii spallacci consentono di trasportarla a mano, a tracolla ed in spalla in modo bilanciato

- Spearfishing bag made in 420D Ripstop fabric
- Plastic zipper closure
- A comfortable and balanced carrying straps are suitable for 3 directions for use: sling bag, shoulder bag and hand bag

COLOR	SIZE	COD.	EAN	€
KRYPSIS	155 x 23 cm	400209K	8056138181052	
BLACK	155 x 23 cm	400209	8058093683794	

CARBON LOOK 20lt - 10lt - 5lt



NEW ARRIVAL

- Borsa stagna multifunzionale per qualsiasi attività outdoor che richiede una protezione totale degli oggetti inseriti
- Saldature stagne, materiale resistente al salino e alle abrasioni
- Sistema "Hands Free", Spallacci esterni regolabili con moschettoni per il trasporto a spalle o tradizionale
- Effetto Carbon Look professional per un ampio e specifico uso
- Multifunctional watertight bag for any outdoor activity that requires total protection of the objects it contains
- Watertight seams, salt and abrasion resistant material
- "Hands Free" system, adjustable external shoulder straps with snap hook for shoulder or traditional carrying
- Professional Carbon Look effect for a wide and specific use

COLOR	CAPACITY	COD.	EAN	€
CARBON LOOK	20lt	BAG0120C	8056138182295	
CARBON LOOK	10lt	BAG0110C	8056138184961	
CARBON LOOK	5lt	BAG0105C	8056138184954	

ICEBERG 30lt



- Contenitore frigo/stagno, flessibile e maneggevole adatto a molteplici funzioni.
- Tessuto anti strappo ad alta resistenza ed elettrosaldato.
- All'interno è presente un rivestimento aggiuntivo con intercapedine con la funzione di reale isolante.
- La borsa può contenere ghiaccio per una più lunga conservazione.
- Forma appositamente studiata per essere collocata in maniera stabile ed eretta su qualsiasi mezzo di trasporto.
- Ideale per il pescatore subacqueo che ha necessità di conservare il pescato in condizioni climatiche calde o estreme.
- Chiusura con cerniera stagna e valvola di scarico per l'acqua.
- Tracolla e manici per il trasporto, asole per fissaggio durante il trasporto
- Scala graduale esterna in cm/pollici per la misurazione del pescato.

- Flexible and handy cooler/watertight container suitable for multiple functions.
- High-strength, electro-welded, tear-resistant fabric.
- Inside there is an additional coating with cavity that acts as a real insulator.
- The bag can hold ice for longer storage.
- Shape specially designed to be placed in a stably and upright on any means of transport.
- Ideal for the spearfisher who needs to keep their catch in hot or extreme weather conditions.
- Watertight zip closure and water drain valve. Shoulder strap and carrying handles
- Eyelets for attachment during transport.
- External scale in cm/inches for measuring the catch.



COLOR	SIZE	COD.	EAN	€
GRAY	length 67,5 cm - height 40 cm . width 20,5cm	400205	8056138181557	



ARTIGLIO

NEW
ARRIVAL

- Pedagno in acciaio inox con apertura ad ombrello e sistema a gravità di bloccaggio
- Peso 500 grammi / Dimensioni contenute 19cm x3cm
- Apertura 12cm
- Ideale per ancorare la pancetta, la boa segna sub, canoa, sup, gonfiabili
- Gli "artigli" alette richiudibili aumentano la tenuta del pedagno in presenza di forte corrente, non creano ingombro e attrito durante il trasposto
- Stainless steel safety marker buoy with umbrella opening and gravity locking system
- Weight 500 grams / Compact dimensions 19cm x3cm
- Opening 12cm
- Ideal for anchoring an inflatable freediving buoy, scuba buoy, canoe, SUP, floats
- The foldable "claws" increase the tightness of the buoy in strong currents and do not create clutter and friction during transport

COD.	EAN	€
ACC0020	8056138185104	

PIOMBO A SGANCIO



- Piombo a sgancio rapido da 950gr rivestito
- Staffa di fissaggio in cintura in acciaio INOX
- Anello inferiore in acciaio INOX per aggancio rapido
- Ideale per pedagnare la boa segna sub
- 950gr coated quick-release lead
- Belt fixing bracket in stainless steel
- Stainless steel bottom ring for quick fastening
- Ideal for anchoring the marker buoy

▶ Suggested Pack: 12 pz

COD.	EAN	€
400850BK	8056138182356	
400850Y	8056138182363	

PLASTIC LEAD



- Pedagno in piombo da 600 grammi, rivestito
- Forma a U studiata per agevolare estrazione e fissaggio in cintura
- Anello inox, in dotazione, per agevolare l'aggancio del moschettone alla sagola boa o al pallone segna sub
- 600 gr lead buoy, coated
- U-shape designed to facilitate extraction and attachment to the belt
- Stainless steel ring, supplied with, to make it easier to attach the snap hook to the buoy line or to the sub signalling ball

▶ Suggested Pack: 12 pz

COD.	EAN	€
400800	8056138180017	

SPOOL LEAD



- Rocchetto in piombo da 400grammi, rivestito
- Forma cilindrica con testa x facilitare l'avvolgimento della sagola
- Ideale per stabilizzare la boa segnasub o segnare rapidamente la zona di pesca
- 400 gr lead spool, coated
- Cylindrical shape with head to facilitate the winding of the line
- Ideal for stabilising the sub signalling buoy or quickly marking the fishing area

▶ Suggested Pack: 12 pz

COD.	EAN	€
400820	8056138180031	

PIOMBO SCHIENALINO



500gr

1000gr

750gr

- Piombo quadrato 7,5x7.5 cm, rivestito
- Studiato per l'inserimento nelle tasche dello schienale Salvimar back pack
- Dotato di fori da 7mm può essere fissato alla sagola e utilizzato come pedagno
- Squared weight 7.5x7.5 cm, coated
- Designed to be inserted in the pockets of the Salvimar back pack
- Equipped with 7mm holes it can be fixed to the line and used as marker buoy

► Suggested Pack: 12 pz

GR.	COLOR	COD.	EAN	€
500	Red	400810	8056138180024	
750	Yellow	400813	8056138180963	
1000	Black	400815	8056138180956	

PIOMBO PER CAVIGLIA



- Piombo per caviglia da 500 grammi, rivestito
- Inserito tra calzare e pantalone consente di equilibrare la spinta positiva del neoprene
- Ideali per praticare pesca all'agguato dove è di fondamentale importanza mantenere le pinne aderenti al fondale
- Rivestito in plastica
- 500 gr ankle weight, coated
- Inserted between socks and trousers it allows to balance the positive thrust of the neoprene
- Ideal for ambush fishing where it is of fundamental importance to keep the fins adherent to the bottom
- Plastic-coated

GR.	COLOR	COD.	EAN	€
500gr	black	400830	8056138180048	
250gr	red	400840	8056138182349	

MANTA 100 DIVE BOARD



- Forma a "Manta": consente una posizione che non affatica la schiena e favorisce la spinta di avanzamento con le pinne
- Spinta di galleggiamento calcolata per sostenere il pescatore dotato di cintura/zavorra invernale
- Tecnologia costruttiva: consente di raggiungere una pressione interna elevata (alta spinta di galleggiamento) e un'alta resistenza all'abrasione
- n° 3 anelli in acciaio INOX inferiori per il traino ed il trasporto
- n° 6 anelli in acciaio INOX superiori per il fissaggio dell'attrezzatura
- Plancetta dotata di:
 - 1 supporto e bandierina segna sub
 - 2 supporto e deriva di stabilizzazione (adatto all'installazione di motore elettrico)
- Pompa di carica e borsa per il trasporto in dotazione

- The "Manta" shape allows a position that does not strain the back and favours the thrust forward with the fins
- Buoyancy thrust calculated to support the fisherman equipped with belt/winter ballast
- Construction technology: allows high internal pressure (high buoyancy thrust) and high abrasion resistance
- 3 lower stainless steel rings for towing and carriage
- 6 upper stainless steel rings for equipment fixing
- Dive board equipped with:
 - 1 support and sub signalling flag
 - 2 support and stabilization centerboard (suitable for installation of an electric motor)
- Charging pump and carrying bag included



**CLICK
HERE**



Charging pump, carrying bag, flag and repair KIT INCLUDED



COD.	EAN	SIZES	€
400503	8058093687778	10x76,3x107,8cm	

MANTA 100 Dive board correct positioning



BARCETTA ALTA VISIBILITA'

- 2 bandierine CMAS e Alpha
- 2 flags CMAS and Alpha



- Plancetta gonfiabile con camera interna in PVC
- Rivestimento esterno in tessuto di nylon ad alta resistenza alle abrasioni
- Colore ad alta visibilità, visibile come da normativa
- Dimensioni calcolate per spinta di galleggiamento 40 kg
- Vano porta oggetti con chiusura velcro
- Asta bandiera maggiorata e rinforzata da 50cm
- Dimensioni bandierina 320x290
- Dotata di fasce cucite in cordura per fissaggio arbalete o pneumatico e vari oggetti di utilizzo.
- In dotazione sagola paleggiante da 25 mt

- Inflatable dive board with PVC inner chamber
- Outer shell in highly abrasion-resistant nylon fabric
- High visibility colour, visible as per regulations
- Dimensions calculated for a buoyancy thrust of 40 kg
- Object holder compartment with Velcro closure
- Oversized and reinforced 50 cm flagpole
- Flag size 320x290
- Equipped with sewn cordura bands for fastening pneumatic guns or spearguns and various objects of use
- Supplied with 25 mt floating rope

COD.	EAN	€
400504	8056138181632	

SPHERA ALTA VISIBILITA'

- 2 bandierine CMAS e Alpha
- 2 flags CMAS and Alpha



- Boa di segnalazione Sub ad alta visibilità
- Camera interna in PVC
- Rivestimento esterno in Nylon rinforzato resistente alle abrasioni
- Doppia bandierina, alpha e rossa banda bianca, fornite di serie
- Fascia in cordura cucita con anello per fissaggio sagola ed eventuali oggetti di uso comune
- Sagola galleggiante da 6mm lunghezza 25 m, in dotazione
- Diametro 360mm, altezza sull'acqua compresa bandierina 500mm

- High visibility diver's buoy
- Inner PVC chamber
- Outer shell in highly abrasion-resistant nylon fabric
- Double alpha red flags with white stripe, supplied as standard
- Stitched cordura band with loop for fixing the line and any objects of common use
- 6 mm floating rope, 25 m long, included
- Diameter 360 mm, height above water including flag 500 mm

COD.	EAN	€
400506	8056138187399	

TORPEDINE ALTA VISIBILITA'



- Boa segnasub a siluro rivestita in tessuto ad alta visibilità by Salvimar con anelli

- Torpedo buoy covered high visibility fabric by Salvimar with rings

► Suggested Pack: 25 pz

COD.	EAN	€
400505	8056138182516	

BOA SILURO IN TESSUTO

- 2 bandierine CMAS e Alpha
- 2 flags CMAS and Alpha



- Boa segnasub a siluro rivestita in tessuto ed anelli
- Torpedo buoy with fabric cover and rings

► Suggested Pack: 25 pz

LENGHT	COD.	EAN	€
84cm	400502	8055960726974	

BOA SILURO PVC

- 2 bandierine CMAS e Alpha
- 2 flags CMAS and Alpha



- Boa segnasub a siluro in PVC ad alto spessore
- Torpedo buoy made with thick PVC

► Suggested Pack: 25 pz

LENGHT	COD.	EAN	€
90cm	400500	8055960725113	

CAMERA INTERNA BOE IN TESSUTO



- Camera interna per boe in tessuto Salvimar: Torpedine e Boa Siluro
- Internal chamber structure foAr Salvimar fabric buoys: Torpedine and Siluro buoy

COD.	EAN	€
400502/A	8056138181205	

BOA SEGNASUB Ø 30cm



- Boa segnasub sferica piccola
- Piombo stabilizzatore più sagola
- Sub signaling little buoy
- Stabilizer lead plus line

► Suggested Pack: 25 pz

COD.	EAN	€
AP025	8055960725366	

DOUBLE BOY Ø 36cm



- Boa segnasub dotata di sagola e avvolgisagola. Munita di alloggio per una bottiglia di acqua da 500ml
- Dive buoy equipped with line, linewinder and room for a 500 ml water bottle

► Suggested Pack: 25 pz

COD.	EAN	€
400501	8055960726967	

ALPHA FLAG



- Bandierina internazionale Alpha
- International Alpha flag

COD.	EAN	€
400500/Z	8055960726981	2,40

FLOAT LINE



- Linea di collegamento tra boa e fucile/asta
- Materiale esterno in PVC (rosso) per avere una buona visibilità a galla
- Anima interna in HMPE da 2mm di diametro, carico di rottura 280 Kg
- Fornita di serie con girella in acciaio inox
- Connection line between buoy and speargun/shaft
- PVC (red) outer material for good visibility afloat
- 2 mm diameter HMPE inner core, breaking strength 280 kg
- Supplied as standard with stainless steel swivel

COLOR	LENGHT	Ø	UTS	COD.	EAN	€
RED	25mt	9mm	270kg	400507	8056138182639	

AVVOLGISAGOLA



- Avvolgisagola
- Le dimensioni dell'avvolgisagola sono state studiate in modo che ad ogni giro di sagola il recupero sia esattamente di 50cm
- Linewinder
- The dimensions of the line winder have been designed so that with each line twist, the retrieve is exactly 50 cm

COLOR	COD.	EAN	€
black	400260	8055960724956	
green	400260G	8056138188501	

BUNGEETECH



- Collegamento elastico tra subacqueo e boa di segnalazione. L'anima interna ha un carico di rottura 80Kg e aumenta la sicurezza di collegamento
- Elastic line connection between the diver and the buoy. The inner core with a tensile strength of 80kg, increases the connection security

TERMINALE

COLOR	LENGHT	Ø	TENSILE STRENGHT (UTS)	COD.	EAN	€
MILITARY GREEN	4 UP TO 16mt	5mm	80kg	400510	8055960726950	
SHINING BLUE	6 UP TO 24mt	5mm	80kg	400512	8056138184077	

BUNGEE



- Collegamento elastico tra boa e arbaete/pneumatico ad allungamento controllato
- Anima interna in Dynema®
- Elastic connection between buoy and sling gun/pneumatic gun with controlled elongation
- Inner core in Dynema®

TERMINALE

COLOR	LENGHT	EXTENSION	Ø	TENSILE STRENGHT (UTS)	COD.	EAN	€
RED	5mt	15mt	Ø9,0mm	160 Kg	400520	8058093688713	
BLACK	10mt	30mt	Ø9,0mm	160Kg	400530	8058093688720	

ESPOSITORE ASTE



Per il tuo negozio, espositore da terra aste Salvimar.
Robusto e compatto, può contenere oltre 800 pz
Design by Salvimar, prodotto Made in Italy

Salvimar Shafts floor-display for your shop
Sturdy and solid, able to hold up to 800 pcs
Design by Salvimar, made in Italy

SIZES

L 70 cm x P 50 cm x H 50 cm

SHAFTS QUANTITY

OVER 800 pz.

COD.

IMBSAL050

CAPTURE



Asta INOX 17-4PH, pinnette realizzate in tecnologia M.I.M. - Metal Injection Molding - applicate con saldatura laser. Nuova aletta a profilo scalato, disponibile mono e doppia aletta

INOX 17-4PH shaft, shark fins realized with M.I.M. technology - Metal Injection Molding - applied with laser welding. New flopper with scaled profile, available with single and double flopper



CAPTURE SINGLE FLOPPER

CAPTURE SHAFT SINGLE BOTTOM FLOPPER - 17-4PH

DIAMETER	LENGHT	COD.	EAN	€
Ø 6,25mm	950mm	901008B	8056138188976	
Ø 6,25mm	1050mm	901008C	8058093681233	
Ø 6,25mm	1100mm	901008C1	8056138183858	
Ø 6,25mm	1150mm	901008D	8058093681196	
Ø 6,25mm	1200mm	901008E	8058093681202	
Ø 6,25mm	1250mm	901008EY	8058093681615	
Ø 6,25mm	1300mm	901008F	8058093681219	
Ø 6,25mm	1350mm	901008FY	8056138182912	
Ø 6,25mm	1400mm	901008G	8058093681226	
Ø 6,25mm	1500mm	901008I	8056138186996	
DIAMETER	LENGHT	COD.	EAN	€
Ø 6,5mm	950mm	901009AY	8058093681622	
Ø 6,5mm	1050mm	901009B	8058093681288	
Ø 6,5mm	1100mm	901009C	8058093684104	
Ø 6,5mm	1150mm	901009D	8058093681295	
Ø 6,5mm	1200mm	901009E	8058093681301	
Ø 6,5mm	1250mm	901009E1	8058093681318	
Ø 6,5mm	1300mm	901009F	8058093681325	
Ø 6,5mm	1350mm	901009F1	8058093684111	
Ø 6,5mm	1400mm	901009G	8058093681332	
Ø 6,5mm	1500mm	901009H	8058093681349	
Ø 6,5mm	1600mm	901009I	8058093683770	
DIAMETER	LENGHT	COD.	EAN	€
Ø 7,0mm	1050mm	901010C	8058093681356	
Ø 7,0mm	1150mm	901010D	8058093681448	
Ø 7,0mm	1200mm	901010E	8058093681462	
Ø 7,0mm	1300mm	901010F	8058093681479	
Ø 7,0mm	1400mm	901010G	8058093681493	
Ø 7,0mm	1500mm	901010H	8058093681516	
Ø 7,0mm	1600mm	901010I	8058093681530	



ALETTA DOPPIA DOUBLE FLOPPER

CAPTURE SHAFT DOUBLE FLOPPER - 17-4PH

DIAMETER	LENGHT	COD.	EAN	€
Ø 6,25mm	1050mm	901008CX	8058093681554	
Ø 6,25mm	1150mm	901008DX	8058093681240	
Ø 6,25mm	1200mm	901008EX	8058093681257	
Ø 6,25mm	1250mm	901008EXY	8058093681639	
Ø 6,25mm	1300mm	901008FX	8058093681264	
Ø 6,25mm	1400mm	901008GX	8058093681271	
DIAMETER	LENGHT	COD.	EAN	€
Ø 6,5mm	950mm	901009AX	8058093681646	
Ø 6,5mm	1050mm	901009BX	8058093681363	
Ø 6,5mm	1100mm	901009CX	8058093684135	
Ø 6,5mm	1150mm	901009DX	8058093681370	
Ø 6,5mm	1200mm	901009EX	8058093681387	
Ø 6,5mm	1250mm	901009E1X	8058093681394	
Ø 6,5mm	1300mm	901009FX	8058093681400	
Ø 6,5mm	1350mm	901009F1X	8058093684142	
Ø 6,5mm	1400mm	901009GX	8058093681417	
Ø 6,5mm	1500mm	901009HX	8058093681424	
DIAMETER	LENGHT	COD.	EAN	€
Ø 7,0mm	1050mm	901010CX	8058093681431	
Ø 7,0mm	1150mm	901010DX	8058093681455	
Ø 7,0mm	1200mm	901010EX	8058093682254	
Ø 7,0mm	1300mm	901010FX	8058093681486	
Ø 7,0mm	1400mm	901010GX	8058093681509	
Ø 7,0mm	1500mm	901010HX	8058093681523	
Ø 7,0mm	1600mm	901010IX	8058093681547	

FOLGORE



Asta INOX 17-4PH, pinnette realizzate in tecnologia M.I.M. - Metal Injection Molding - applicate con saldatura laser. Nuova aletta a profilo scalato, disponibile mono aletta. **Aletta non incassata**

INOX 17-4PH shaft, shark fins realized with M.I.M. technology - Metal Injection Molding - applied with laser welding. New flopper with scaled profile, available with single flopper. **Not embedded flopper**



FOLGORE SINGLE FLOPPER

FOLGORE SHAFT SINGLE BOTTOM FLOPPER - 17-4PH

DIAMETER	LENGTH	COD.	EAN	€
Ø 6,50mm	1050mm	901011B	8058093687020	
Ø 6,50mm	1150mm	901011D	8058093687037	
Ø 6,50mm	1200mm	901011E	8058093687044	
Ø 6,50mm	1250mm	901011E1	8058093687051	
Ø 6,50mm	1300mm	901011F	8058093687068	
Ø 6,50mm	1400mm	901011G	8058093687075	
Ø 6,50mm	1500mm	901011H	8058093687082	

BOLT



- Asta Bolt con sistema brevettato di collimazione della linea di vista (line of sight collimation)
- Grazie ad una particolare fresatura del cordolo l'asta Bolt si accoppia perfettamente con il castello di sgancio dell'arbaete Ares
- La soluzione mantiene l'asta allineata al guida asta, impedendo movimenti laterali
- In fase di lancio, l'energia degli elastici è trasferita al centro di spinta, le oscillazioni nella coda dell'asta risultano minori, ottenendo un tiro molto preciso, stabile e con maggiore penetrazione
- Materiale: 174Ph / Pinnetta: realizzata con tecnologia MIM (metal injection moulding). Saldatura laser / Aletta: Capture

- Shaft Bolt with patented line-of-sight collimation system
- Thanks to a special milling of the seam, the shaft Bolt fits perfectly with the release mechanism box of the Ares speargun
- This solution keeps the shaft aligned with the shaft guide, preventing lateral movements
- When launching, the energy of the bands is transferred to the thrust centre, the oscillations in the tail of the shaft are smaller, obtaining a very precise, stable shoot with greater penetration
- Material: 174Ph / Fin: made using MIM (metal injection moulding) technology. Laser welding / Flap: Capture

NEW ARRIVAL

BOLT SHAFT SINGLE BOTTOM FLOPPER - 17-4PH



BOLT SINGLE FLOPPER

DIAMETER	LENGTH	COD.	EAN	€
Ø 6,5 mm	900mm	AA165090	8056138188945	
Ø 6,5 mm	1050mm	AA165105	8056138185333	
Ø 6,5 mm	1150mm	AA165115	8056138185340	
Ø 6,5 mm	1250mm	AA165125	8056138185357	
Ø 6,5 mm	1350mm	AA165135	8056138185364	
DIAMETER	LENGTH	COD.	EAN	€
Ø7,0 mm	1050mm	AA170105	8056138188037	
Ø7,0 mm	1150mm	AA170115	8056138188044	
Ø7,0 mm	1250mm	AA170125	8056138188051	
Ø7,0 mm	1350mm	AA170135	8056138188068	

PACIFIC



Asta INOX 17-4PH. pinnette realizzate in tecnologia M.I.M. Estremamente resistente, aletta rinforzata adatta alla pesca di grandi prede

INOX 17-4PH shark fins realized with M.I.M. technology. Extremely durable, reinforced flopper suitable for "Big game hunting"



PACIFIC SINGLE FLOPPER

PACIFIC SHAFT SINGLE BOTTOM FLOPPER - 17-4PH

DIAMETER	LENGHT	COD.	EAN	€
Ø 7,0mm	1200mm	901005E	8057685553163	
Ø 7,0mm	1250mm	901005E1	8056138183865	
Ø 7,0mm	1300mm	901005F	8057685553170	
Ø 7,0mm	1400mm	901005G	8057685553187	
Ø 7,0mm	1500mm	901005H	8057685553194	
Ø 7,0mm	1600mm	901005I	8057685553200	
Ø 7,0mm	1700mm	901005L	8057685554368	

DIAMETER	LENGHT	COD.	EAN	€
Ø 7,5mm	1300mm	901006F	8057685553279	
Ø 7,5mm	1400mm	901006G	8057685553286	
Ø 7,5mm	1500mm	901006H	8057685553354	
Ø 7,5mm	1600mm	901006I	8057685553385	
Ø 7,5mm	1700mm	901006L	8057685554375	
Ø 7,5mm	1800mm	901006M	8057685554382	

DIAMETER	LENGHT	COD.	EAN	€
Ø 8,0mm	1300mm	901007F	8057685553477	
Ø 8,0mm	1400mm	901007G	8057685553484	
Ø 8,0mm	1500mm	901007H	8057685553491	
Ø 8,0mm	1600mm	901007I	8057685554399	
Ø 8,0mm	1700mm	901007L	8057685554405	
Ø 8,0mm	1800mm	901007M	8056138181137	

CAPTURE TRICUSPIDE SANDVIK



Asta in acciaio SANDVIK, pinnette realizzate in tecnologia M.I.M. - Metal Injection Molding - applicate con saldatura laser. Punta tricuspid per una perfetta perforazione

Sandvik steel shaft, shark fins realized with M.I.M. - Metal Injection Molding - applied with laser welding. Tricuspid tip for perfect penetration



CAPTURE SINGLE FLOPPER

CAPTURE TRICUSPIDE SHAFT SINGLE BOTTOM FLOPPER - SANDVIK

DIAMETER	LENGHT	COD.	EAN	€
Ø 6,5mm	1050mm	908010D	8058093681806	
Ø 6,5mm	1150mm	908010F	8058093681813	
Ø 6,5mm	1200mm	908010H	8058093681820	
Ø 6,5mm	1250mm	908010L	8058093682261	
Ø 6,5mm	1300mm	908010N	8058093681837	
Ø 6,5mm	1400mm	908010P	8058093681844	
Ø 6,5mm	1500mm	908010R	8058093681851	

PACIFIC SFALSATA

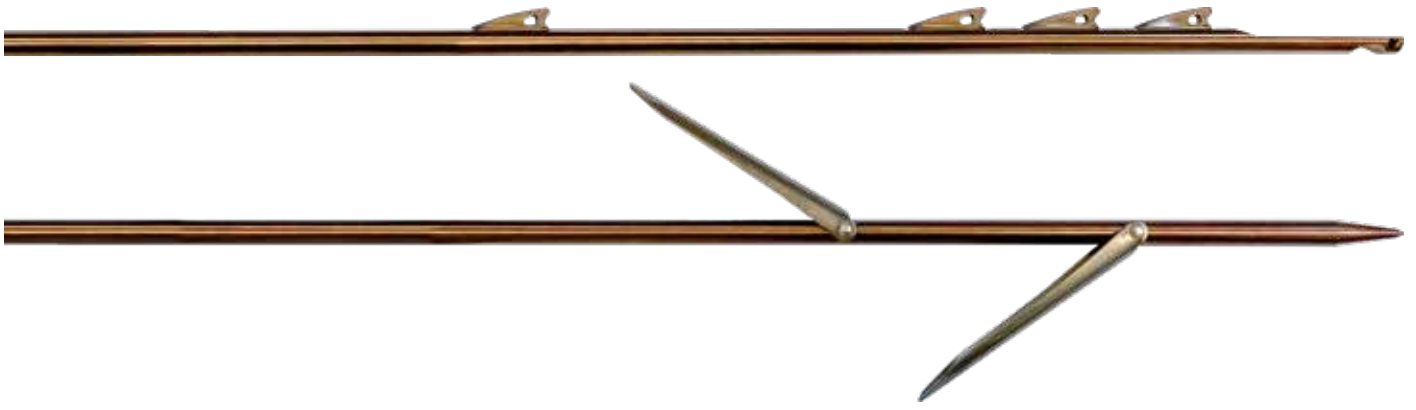

- Asta inox 174Ph
- Pinnette realizzate in tecnologia MIM
- 2 alette rinforzate sfalsate adatte alla pesca di grosse prede

NEW ARRIVAL

- INOX 17-4PH hark
- Fins realized with M.I.M. technology
- 2 staggered reinforced floppers suitable for "Big game hunting"

PACIFIC SFALSATA SHAFT DOUBLE FLOPPER - 17-4PH

DIAMETER	LENGHT	COD.	EAN	€
Ø 7,5 mm	1600mm	AA275160	8056138186057	
Ø 7,5 mm	1700mm	AA275170	8056138186064	
Ø 7,5 mm	1800mm	AA275180	8056138186071	
DIAMETER	LENGHT	COD.	EAN	€
Ø 8,0 mm	1500mm	AA280150	8056138186231	
Ø 8,0 mm	1600mm	AA280160	8056138186088	
Ø 8,0 mm	1700mm	AA280170	8056138186095	
Ø 8,0 mm	1800mm	AA280180	8056138186101	

PACIFIC FILETTATA Ø 7mm



Asta INOX 17-4PH. Pinnette saldate laser. Estremamente resistente, terminale filettato.
INOX 17-4PH shaft. Laser welded shark fins. Extremely durable, threaded end

PACIFIC SHAFT FILETTATA 17-4PH - M7



FILETTATA SCREWED M7

DIAMETER	LENGHT	COD.	EAN	€
Ø 7,0mm	1250mm	905125P	8057685557888	
Ø 7,0mm	1350mm	905135P	8057685557895	
Ø 7,0mm	1450mm	905145P	8057685557901	
Ø 7,0mm	1550mm	905155P	8057685557918	

PACIFIC FILETTATA Ø 8mm



PACIFIC SHAFT FILETTATA 17-4PH - M7



FILETTATA SCREWED M7

DIAMETER	LENGHT	COD.	EAN	€
Ø 8,0mm	1400mm	AAF80140	8056138186118	
Ø 8,0mm	1500mm	AAF80150	8056138186132	
Ø 8,0mm	1600mm	AAF80160	8056138186149	
Ø 8,0mm	1700mm	AAF80170	8056138186156	

TAHITIANA TACCHE



Tacche tradizionali idrodinamiche, ottimo rapporto qualità/prezzo

Hydrodynamic traditional notches, good value quality/price

SHAFTS



TAHITIANA SINGLE FLOPPER



DOUBLE FLOPPER



FILETTATA SCREWED



TAHITIANA BLACK SINGLE FLOPPER



FILETTATA SCREWED

TAHITIANA TACCHE SHAFT SINGLE FLOPPER ON TOP - 17-4PH

DIAMETER	LENGHT	COD.	EAN	€
Ø 6,0mm	850mm	AH098/SP05	8055960729203	
Ø 6,0mm	950mm	AH098/SP06	8055960729210	
Ø 6,0mm	1050mm	AH098/SP07	8055960729227	
Ø 6,0mm	1100mm	AH098/SP09	8055960729234	
Ø 6,0mm	1150mm	AH098/SP10	8055960729241	
Ø 6,0mm	1200mm	AH098/SP12	8055960729258	
Ø 6,0mm	1250mm	AH098/SP14	8056138186941	
Ø 6,0mm	1300mm	AH098/SP15	8055960729265	
Ø 6,0mm	1350mm	AH098/SP16	8056138186958	
Ø 6,0mm	1400mm	AH098/SP20	8055960729272	
Ø 6,0mm	1450mm	AH098/SP21	8056138186965	
Ø 6,0mm	1500mm	AH098/SP25	8056138186989	
Ø 6,0mm	1600mm	AH0987sp30	8056138186989	

DIAMETER	LENGHT	COD.	EAN	€
Ø 6,25mm	850mm	AH099/SP05	8055960729289	
Ø 6,25mm	950mm	AH099/SP06	8055960729296	
Ø 6,25mm	1050mm	AH099/SP07	8055960729302	
Ø 6,25mm	1100mm	AH099/SP08	8055960729319	
Ø 6,25mm	1150mm	AH099/SP10	8055960729326	
Ø 6,25mm	1200mm	AH099/SP12	8055960729333	
Ø 6,25mm	1250mm	AH099/SP13	8056138182929	
Ø 6,25mm	1300mm	AH099/SP15	8055960729340	
Ø 6,25mm	1400mm	AH099/SP20	8055960729357	
Ø 6,25mm	1450mm	AH099/SP21	8056138187009	
Ø 6,25mm	1500mm	AH099/SP25	8055960729364	
Ø 6,25mm	1600mm	AH099/SP25/1	8056138188983	

DIAMETER	LENGHT	COD.	EAN	€
Ø 6,5mm	700mm	AH178	8056138182677	
Ø 6,5mm	850mm	AH180	8055960729463	
Ø 6,5mm	950mm	AH181	8055960729470	
Ø 6,5mm	1050mm	AH182	8055960729487	
Ø 6,5mm	1100mm	AH184	8055960729494	
Ø 6,5mm	1150mm	AH195	8055960729500	
Ø 6,5mm	1200mm	AH195/1	8055960729517	
Ø 6,5mm	1250mm	AH195/2	8056138182936	
Ø 6,5mm	1300mm	AH196	8055960729524	
Ø 6,5mm	1350mm	AH196/1	8056138183247	
Ø 6,5mm	1400mm	AH197	8055960729531	
Ø 6,5mm	1450mm	AH197/1	8056138187016	
Ø 6,5mm	1500mm	AH198	8055960729548	
Ø 6,5mm	1600mm	AH200	8058093689390	

TAHITIANA TACCHE SHAFT DOUBLE FLOPPER - 17-4PH

DIAMETER	LENGHT	COD.	EAN	€
Ø 6,5mm	850mm	AH150	8055960729555	
Ø 6,5mm	950mm	AH151	8055960729562	
Ø 6,5mm	1050mm	AH152	8055960729579	
Ø 6,5mm	1100mm	AH154	8055960729586	
Ø 6,5mm	1150mm	AH160	8055960729593	
Ø 6,5mm	1200mm	AH162	8055960729609	
Ø 6,5mm	1300mm	AH165	8055960729616	
Ø 6,5mm	1400mm	AH170	8055960729623	
Ø 6,5mm	1500mm	AH175	8055960729630	

TAHITIANA TACCHE SHAFT FILETTATA - 17 4PH

DIAMETER	LENGHT	COD.	EAN	€
Ø 6,5mm	600mm	AG879	8055960729647	
Ø 6,5mm	620mm	AG879/1	8056138180710	
Ø 6,5mm	680mm	AG880	8055960729654	
Ø 6,5mm	720mm	AG881	8056138180437	
Ø 6,5mm	750mm	AG882	8055960729661	
Ø 6,5mm	800mm	AG885	8055960729678	
Ø 6,5mm	820mm	AG885/1	8056138180727	
Ø 6,5mm	850mm	AG886	8055960729685	
Ø 6,5mm	970mm	AG887	8055960729692	
Ø 6,5mm	1100mm	AG890	8055960729708	
Ø 6,5mm	1250mm	AG892	8055960729715	
Ø 6,5mm	1350mm	AG894	8055960729722	

TAHITIANA TACCHE BLACK SHAFT GALVANIZZATA SINGLE FLOPPER ON TOP - 17-4PH

DIAMETER	LENGHT	COD.	EAN	€
Ø 6,5mm	750mm	AG856	8058093684890	
Ø 6,5mm	850mm	AG861	8058093684906	
Ø 6,5mm	950mm	AG866	8058093684913	
Ø 6,5mm	1150mm	AG871	8058093684920	

TAHITIANA TACCHE BLACK SHAFT GALVANIZZATA FILETTATA - 17 4PH

DIAMETER	LENGHT	COD.	EAN	€
Ø 6,5mm	620mm	AG835	8058093684852	
Ø 6,5mm	720mm	AG840	8058093684869	
Ø 6,5mm	820mm	AG842	8058093684876	
Ø 6,5mm	970mm	AG844	8058093684883	

SALVIMAR SPEARFISHING

TOP ARBALETE SUGGESTED SHAFTS

ARBALETE SPEARGUNS	SHAFTS DESCRIPTION	COD.
ARES 60	Asta/Shaft BOLT mono aletta ø 6,50 mm - 900 mm	AA165090
ARES 75	Asta/Shaft BOLT mono aletta ø 6,50 mm - 1050 mm	AA165105
ARES 85	Asta/Shaft BOLT mono aletta ø 6,50 mm - 1150 mm	AA165115
ARES 95	Asta/Shaft BOLT mono aletta ø 6,50 mm - 1250 mm	AA165125
ARES 105	Asta/Shaft BOLT mono aletta ø 6,50 mm - 1350 mm	AA165135
ARES NIGHTMARE 75	Asta/Shaft BOLT mono aletta ø 7,00 mm - 1050 mm	AA170105
ARES NIGHTMARE 85	Asta/Shaft BOLT mono aletta ø 7,00 mm - 1150 mm	AA170115
ARES NIGHTMARE 95	Asta/Shaft BOLT mono aletta ø 7,00 mm - 1250 mm	AA170125
ARES NIGHTMARE 105	Asta/Shaft BOLT mono aletta ø 7,00 mm - 1350 mm	AA170135
METAL 60/METAL ROLLER 60/METAL CARBO ROLLER/METAL KRYPISIS 60/V-PRO 60/WILD CARBO OPEN 60	Asta/Shaft CAPTURE mono aletta ø 6,50 mm - 950 mm	901009AY
METAL 75/METAL ROLLER 75/METAL CARBO ROLLER/METAL KRYPISIS 75/V-PRO 75/WILD CARBO OPEN 75	Asta/Shaft CAPTURE mono aletta ø 6,50 mm - 1100 mm	901009C
METAL 85/METAL ROLLER 85/METAL CARBO ROLLER/METAL KRYPISIS 85/V-PRO 85/WILD CARBO OPEN 85	Asta/Shaft CAPTURE mono aletta ø 6,50 mm - 1200 mm	901009E
METAL 95 / METAL CARBO OPEN 95 / METAL ROLLER 95 /METAL KRYPISIS 95 / V-PRO 95	Asta/Shaft CAPTURE mono aletta ø 6,50 mm - 1300 mm	901009F
METAL 105 / METAL CARBO OPEN 105 /METAL ROLLER 105 /METAL KRYPISIS 105 /V-PRO 105	Asta/Shaft CAPTURE mono aletta ø 6,50 mm - 1400 mm	901009G
METAL CARBO OPEN 115 /METAL ROLLER 115	Asta/Shaft CAPTURE mono aletta ø 6,50 mm - 1500 mm	901009H
METAL ROLLER 125	Asta/Shaft CAPTURE mono aletta ø 6,50 mm - 1600 mm	901009I
METAL CARBO ROLLER 95	Asta/Shaft CAPTURE mono aletta ø 7.0mm - 1300 mm	901010F
METAL CARBO ROLLER 105	Asta/Shaft CAPTURE mono aletta ø 7.0mm - 1400 mm	901010G
METAL 115/METAL KRYPISIS 115 / METAL CARBO ROLLER 115	Asta/Shaft CAPTURE mono aletta ø 7.0mm - 1500 mm	901010H
METAL 125	Asta/Shaft CAPTURE mono aletta ø 7.0mm - 1600 mm	901010I
WILD CARBO 60 / VOODOO 60	Asta/Shaft TAHITIANA TACCHE mono aletta ø 6.5mm - 950 mm	AH181
WILD CARBO 75 / VOODOO 75	Asta/Shaft TAHITIANA TACCHE mono aletta ø 6.5mm - 1100 mm	AH184
WILD CARBO 85 / VOODOO 85	Asta/Shaft TAHITIANA TACCHE mono aletta ø 6.5mm - 1200 mm	AH195/1
VOODOO 95	Asta/Shaft TAHITIANA TACCHE mono aletta ø 6.5mm - 1300 mm	AH196
VOODOO 105	Asta/Shaft TAHITIANA TACCHE mono aletta ø 6.5mm - 1400 mm	AH197
HERO 65 / HERO TOMAHAWK 65	Asta/Shaft CAPTURE mono aletta ø 7.0mm - 1050 mm	901010C
HERO 75 / HERO TOMAHAWK 75 / HERO NIGHTMARE 75	Asta/Shaft CAPTURE mono aletta ø 7.0mm - 1150 mm	901010D
HERO 85 / HERO TOMAHAWK 85 / HERO NIGHTMARE 85 / HERO STORM 85	Asta/Shaft CAPTURE mono aletta ø 7.0mm - 1200 mm	901010E
HERO 95 / HERO NIGHTMARE 95 / HERO STORM 95	Asta/Shaft CAPTURE mono aletta ø 7.0mm - 1300 mm	901010F
TOMAHAWK 95	Asta/Shaft PACIFIC mono aletta ø 7.5mm - 1300 mm	901006F
HERO 105 / HERO TOMAHAWK 105 / HERO NIGHTMARE 105 / HERO STORM 105	Asta/Shaft PACIFIC mono aletta ø 7.5mm - 1400 mm	901006G
HERO 115 / HERO TOMAHAWK 115 / HERO NIGHTMARE 115 / HERO STORM 115	Asta/Shaft PACIFIC mono aletta ø 7.5mm - 1500 mm	901006H
HERO 125 / HERO TOMAHAWK 125 / HERO NIGHTMARE 125	Asta/Shaft PACIFIC mono aletta ø 7,5mm - 1700 mm	901006L
HERO 135 / HERO TOMAHAWK 135	Asta/Shaft PACIFIC mono aletta ø 7,5mm - 1800 mm	901006M
HERO ROLLER 65	Asta/Shaft CAPTURE mono aletta ø 7.0mm - 1050 mm	901010C
HERO ROLLER 75	Asta/Shaft CAPTURE mono aletta ø 7.0mm - 1150 mm	901010D
HERO ROLLER 85	Asta/Shaft CAPTURE mono aletta ø 7.0mm - 1200 mm	901010E
HERO ROLLER 95	Asta/Shaft CAPTURE mono aletta ø 7.0mm - 1300 mm	901010F
HERO ROLLER 105	Asta/Shaft PACIFIC mono aletta ø 7.5mm - 1400 mm	901006G
HERO ROLLER 115	Asta/Shaft PACIFIC mono aletta ø 7.5mm - 1500 mm	901006H
HERO ROLLER 125	Asta/Shaft PACIFIC mono aletta ø 7,5mm - 1700 mm	901006L
HERO ROLLER 135	Asta/Shaft PACIFIC mono aletta ø 7,5mm - 1800 mm	901006M
WILD CARBO STONE 40	Asta/Shaft TAHITIANA TACCHE filettata ø 6.5mm - 620 mm	AG879/1
WILD CARBO STONE 50	Asta/Shaft TAHITIANA TACCHE filettata ø 6.5mm - 720 mm	AG881
WILD CARBO STONE 60	Asta/Shaft TAHITIANA TACCHE filettata ø 6.5mm - 820 mm	AG885/1
WILD CARBO STONE 75	Asta/Shaft TAHITIANA TACCHE filettata ø 6.5mm - 970 mm	AG887
WILD 40	Asta/Shaft TAHITIANA TACCHE filettata ø 6.5mm - 620 mm	AG835
WILD 50	Asta/Shaft TAHITIANA TACCHE filettata ø 6.5mm - 720 mm	AG840
WILD 60	Asta/Shaft TAHITIANA TACCHE filettata ø 6.5mm - 820 mm	AG842
WILD 75	Asta/Shaft TAHITIANA TACCHE filettata ø 6.5mm - 970 mm	AG844
WILD PRO 40	Asta/Shaft TAHITIANA TACCHE mono aletta ø 6.5mm - 750 mm	AG856
WILD PRO 50	Asta/Shaft TAHITIANA TACCHE mono aletta ø 6.5mm - 850 mm	AG861
WILD PRO 60	Asta/Shaft TAHITIANA TACCHE mono aletta ø 6.5mm - 950 mm	AG866
WILD PRO 75	Asta/Shaft TAHITIANA TACCHE mono aletta ø 6.5mm - 1150 mm	AG871
METAL MONO 60 / MONO RAIL 60	Asta/Shaft CAPTURE mono aletta ø 6,25 mm - 950 mm	901008B
METAL MONO 75 / MONO RAIL 75	Asta/Shaft CAPTURE mono aletta ø 6,25 mm - 1100 mm	901008C1
METAL MONO 85 / MONO RAIL 85	Asta/Shaft CAPTURE mono aletta ø 6,25 mm - 1200 mm	901008E

AIR TAHITIANA



Asta per fucili pneumatici, fornita con rondella e scorri sagola e codolo a scelta per tutte le marche
Shaft for pneumatic guns, supplied with washer and line slider, tail choice for all brands

AIR TAHITIANA Ø 7,0 SHAFT SINGLE FLOPPER - 17-4PH



CAPTURE SINGLE FLOPPER

DIAMETER	LENGHT*		COD.	EAN	€
Ø 7,0mm	620mm	Salvimar 55 - Cyrano 550	AG305	8055960724291	
Ø 7,0mm	770mm	Salvimar 65 - Cyrano 700	AG315	8055960724307	
Ø 7,0mm	870mm	Salvimar 75	AG317	8055960724314	
Ø 7,0mm	900mm	Cyrano 850	AG330	8055960724321	
Ø 7,0mm	970mm	Salvimar 85	AG334	8057685552227	
Ø 7,0mm	1050mm	Cyrano 970	AG340	8055960724239	
Ø 7,0mm	1120mm	Salvimar 100	AG341	8055960724246	
Ø 7,0mm	1200mm	Cyrano 1100	AG350	8055960724260	
Ø 7,0mm	1270mm	Salvimar 115	AG352	8057685552364	
Ø 7,0mm	1420mm	Salvimar 130	AG355	8058093682667	

AIR TAHITIANA Ø 7,0 SHAFT DOUBLE FLOPPER - 17-4PH



ALETTA DOPPIA DOUBLE FLOPPER

DIAMETER	LENGHT*		COD.	EAN	€
Ø 7,0mm	620mm	Salvimar 55 - Cyrano 550	AG305B	8055960724277	
Ø 7,0mm	770mm	Salvimar 65 - Cyrano 700	AG315B	8055960724086	
Ø 7,0mm	870mm	Salvimar 75	AG317B	8055960724093	
Ø 7,0mm	900mm	Cyrano 850	AG330B	8055960724109	
Ø 7,0mm	970mm	Salvimar 85	AG334B	8057685552487	
Ø 7,0mm	1050mm	Cyrano 970	AG340B	8055960724116	
Ø 7,0mm	1120mm	Salvimar 100	AG341B	8055960724123	
Ø 7,0mm	1200mm	Cyrano 1100	AG350B	8055960725380	
Ø 7,0mm	1270mm	Salvimar 115	AG352B	8057685552494	
Ø 7,0mm	1420mm	Salvimar 130	AG355B	8058093682681	

FILETTATA Ø 7,0 SHAFT 17-4PH



FILETTATA SCREWED

DIAMETER	LENGHT*		COD.	EAN	€
Ø 7,0mm	350mm	Salvimar 40 - Cyrano/Sten	AG190/174PH	8056138181274	
Ø 7,0mm	512mm	Salvimar 55 - Cyrano/Sten	AG200/174PH	8058093689727	
Ø 7,0mm	662mm	Salvimar 65 - Cyrano/Sten	AG210/174PH	8058093689734	
Ø 7,0mm	812mm	Salvimar 85 - Cyrano/Sten	AG220/174PH	8058093689741	

*Misure riferite ad asta senza codolo - Sizes refer to the shafts with no tail

AIR TAHITIANA Ø 7,0 SHAFT FLOPPER - 17-4PH - 45° ANGLE TILT



ALETTA SINGOLA SINGLE FLOPPER



ALETTA DOPPIA DOUBLE FLOPPER



FILETTATA SCREWED

AIR TAHITIANA Ø 7,0 SHAFT SINGLE FLOPPER - 17-4PH - 45° ANGLE TILT

DIAMETER	LENGHT*		COD.	EAN	€
Ø 7,0mm	870mm	Salvimar 75	APNE170087	8056138181304	
Ø 7,0mm	970mm	Salvimar 85	APNE170097	8056138181311	
Ø 7,0mm	1120mm	Salvimar 100	APNE170112	8056138181328	

AIR TAHITIANA Ø 7,0 SHAFT DOUBLE FLOPPER - 17-4PH - 45° ANGLE TILT

DIAMETER	LENGHT*		COD.	EAN	€
Ø 7,0mm	870mm	Salvimar 75	APNE270087	8056138180901	
Ø 7,0mm	970mm	Salvimar 85	APNE270097	8056138180925	
Ø 7,0mm	1120mm	Salvimar 100	APNE2700112	8056138180932	

FILETTATA Ø 7,0 SHAFT 17-4PH - 45° ANGLE TILT

DIAMETER	LENGHT*		COD.	EAN	€
Ø 7,0mm	350mm	Salvimar 40	APNE070035	8056138181335	
Ø 7,0mm	512mm	Salvimar 55	APNE070051	8056138181342	
Ø 7,0mm	662mm	Salvimar 65	APNE070066	8056138181359	

AIR TAHITIANA Ø 7,5 SHAFT FLOPPER - 17-4PH



ALETTA DOPPIA DOUBLE FLOPPER



PACIFIC SINGLE FLOPPER

AIR TAHITIANA Ø 7,5 SHAFT DOUBLE FLOPPER - 17-4PH - 45° ANGLE TILT

DIAMETER	LENGHT*		COD.	EAN	€
Ø 7,5mm	970mm	Salvimar 85	907204D	8058093681899	
Ø 7,5mm	1120mm	Salvimar 100	907204F	8058093681905	
Ø 7,5mm	1270mm	Salvimar 115	907204H	8058093681912	
Ø 7,5mm	1420mm	Salvimar 130	907204L	8058093684128	

AIR TAHITIANA Ø 7,5 SHAFT SINGLE FLOPPER - 17-4PH - 45° ANGLE TILT

DIAMETER	LENGHT*		COD.	EAN	€
Ø 7,5mm	970mm	Salvimar 85	907202D	8058093681868	
Ø 7,5mm	1120mm	Salvimar 100	907202F	8058093681875	
Ø 7,5mm	1270mm	Salvimar 115	907202H	8058093681882	
Ø 7,5mm	1420mm	Salvimar 130	907202L	8056138181298	

*Misure riferite ad asta senza codolo - Sizes refer to the shafts with no tail

AIR TAHITIANA Ø 8,0 SHAFT SINGLE FLOPPER - 17-4PH



PACIFIC SINGLE FLOPPER

DIAMETER	LENGHT*		COD.	EAN	€
Ø 8,0mm	1120mm	Salvimar 100	907200/L	8055960724406	
Ø 8,0mm	1270mm	Salvimar 115	907200/M	8055960724130	
Ø 8,0mm	1420mm	Salvimar 130	907200/N	8055960724284	

FILETTATA INOX



FILETTATA SCREWED

DIAMETER	LENGHT*		COD.	EAN	€
Ø 7,0mm	932mm	Salvimar 85 - Cyrano 970	AG235	8055960729043	
Ø 7,0mm	1082mm	Salvimar 100 - Cyrano 1100	AG245	8055960729050	
DIAMETER	LENGHT*		COD.	EAN	€
Ø 8,0mm	350mm	Salvimar 40 - Miniministen	AG003	8055960727209	
Ø 8,0mm	500mm	Salvimar 55 - Ministen	AG007	8055960727216	
Ø 8,0mm	650mm	Salvimar 65 - Menisten	AG011	8055960727223	
Ø 8,0mm	750mm	Salvimar 75 - Mirage	AG015	8055960727230	
Ø 8,0mm	850mm	Salvimar 85 - Sten	AG019	8055960727247	
Ø 8,0mm	970mm	Salvimar 100 - upersten	AG023	8055960727254	
Ø 8,0mm	1070mm	Sten 115	AG027	8055960727261	
DIAMETER	LENGHT*		COD.	EAN	€
Ø 8,0mm	220mm	Asso30	AG055	8055960726271	
Ø 8,0mm	350mm	Asso40 - SL40	AG065	8055960726288	
Ø 8,0mm	500mm	Asso50 - SL55	AG075	8055960726295	
Ø 8,0mm	650mm	Asso65 - SL70	AG085	8055960726301	
Ø 8,0mm	750mm	Asso75	AG095	8055960726318	
Ø 8,0mm	850mm	Asso90	AG105	8055960726325	
Ø 8,0mm	950mm	SL100	AG086	8057685557925	

FILETTATA ZINCATA / GALVANIZED



FILETTATA SCREWED

DIAMETER	LENGHT*		COD.	EAN	€
Ø 7,0mm	812mm	Salvimar 75 - Cyrano 850	AG220	8055960724499	
Ø 7,0mm	932mm	Salvimar 85 - Cyrano 970	AG230	8055960725571	
Ø 7,0mm	1082mm	Salvimar 100 - Cyrano 1100	AG240	8055960724840	
DIAMETER	LENGHT*		COD.	EAN	€
Ø 8,0mm	350mm	Salvimar 40 - Miniministen	AG001	8055960727278	
Ø 8,0mm	500mm	Salvimar 55 - Ministen	AG005	8055960727285	
Ø 8,0mm	650mm	Salvimar 65 - Medisten	AG009	8055960727292	
Ø 8,0mm	750mm	Salvimar 75 - Mirage	AG013	8055960727308	
Ø 8,0mm	850mm	Salvimar 85 - Sten	AG017	8055960727315	
Ø 8,0mm	970mm	Salvimar 100 - Supersten	AG021	8055960727322	
DIAMETER	LENGHT*		COD.	EAN	€
Ø 8,0mm	350mm	Asso40	AG060	8055960726141	
Ø 8,0mm	500mm	Asso50	AG070	8055960726134	
Ø 8,0mm	650mm	Asso65	AG080	8055960726158	
Ø 8,0mm	750mm	Asso75	AG090	8055960726172	
Ø 8,0mm	850mm	Asso90	AG100	8055960726189	
Ø 8,0mm	1150mm	Asso 115	AG110	8055960726196	
Ø 8,0mm	950mm	SL100	AG170	8055960726202	

*Misure riferite ad asta senza codolo - Sizes refer to the shafts with no tail



SLIP TIP CLAW Ø8,5 mm

- Punta a sgancio rapido in acciaio inox 17-4 ph trattato termicamente
- Dotato di ardiglione posteriore integrato realizzato in fase di lavorazione meccanica
- Profilo idrodinamico con sede di fissaggio sagola ribassata con angoli smussati
- Fresatura inferiore dedicata al diametro della sagola di ritenuta
- Sistema di rilascio rapido, testa sferica calibrata compatibile con aste filettate M7
- Scorri asta in acciaio inox incompatibile con aste diametro 7, 7,5 e 8mm
- In dotazione sagola rivestita in PU Mono Green da 1,8mm carico di rottura 350Kg

- Quick-release tip in heat-treated 17-4 ph stainless steel
- Equipped with integrated rear barb made during mechanical processing
- Hydrodynamic profile with lowered line-fixing seat with chamfered corners
- Lower milling for the diameter of the retaining line
- Quick release system, calibrated ball head compatible with M7 threaded rods
- Stainless steel shaft slide incompatible with 7, 7.5 and 8mm diameter shafts
- Supplied with a 1.8 mm PU coated Mono Green line, breaking load 350 Kg

KIT	COD.	EAN	€
1 Kit	AC065	8056138184381	

- Raccordo filettato 5/16 - M6
- Adapter thread 5/16 - M6



KIT	TREAD	COD.	EAN	€
Kit 2 pz	5/16	AC060/C	8055960724727	
Kit 2 pz	M6	AC060/D	8057685559066	
Kit 2 pz	M7	AC060/B	8058093682902	

- Scorriasta ad anello, ferma cavetto Slip-Tip per asta Ø 6,5/7,0 - 7,5 - 8 mm

- Ring shaft slider, Slip-Tip cable retainer for Ø 6.5/7.0 - 7.5 - 8 mm rod



KIT	Ø	COD.	EAN	€
Kit 2 pz	6,5mm	AC060/I	8058093684661	
Kit 2 pz	7mm	AC060/F	8055960724741	
Kit 2 pz	7,5mm	AC060/G	8055960724758	
Kit 2 pz	8mm	AC060/H	8055960724765	

- Cavetto acciaio inox testato 270 kg
- Stainless steel tested cable 270 kg



KIT	COD.	EAN	€
Kit 2 pz	AE083	8055960725816	

- Cono in acciaio inox 174ph per asta Tahitiana

- Cone in stainless steel for tahitian



DIAMETER	KIT	COD.	EAN	€
Ø 6,5mm	Kit 5 pz	AE034/A	8057685550698	
Ø 7,0mm	Kit 5 pz	AE034/B	8057685550704	
Ø 7,5mm	Kit 5 pz	AE034/C	8057685557932	

SCORRISAGOLA



- Scorisagola in nylon caricato vetro
- Sede della sagola inglobata
- Maggiore trazione a forte carico
- Low profile fiberglass loaded nylon slide ring
- High strength channeled design for robustness in the area in contact with the shaft

mm	COD.	EAN	€
Ø 7,0mm	AE025/B	8057685557116	
Ø 8,0mm	AE025/D	8057685557130	

SCORRISAGOLA MIM + RONDELLA



- Scorisagola MIM in INOX 17.4PH
- Disponibile nei diametri: 7mm / 7,5mm / 8mm

- MIM line slider in 17.4PH STAINLESS STEEL
- Available in diameters: 7mm / 7.5mm / 8mm



MM	CONF.	COD.	EAN	€
7,0mm	5pz	AE027/B	8056138186002	
7,5mm	5pz	AE027/C	8056138186019	
8,0mm	5pz	AE027/D	8056138186026	

SCORRISAGOLA + CODOLO 45° + RONDELLA



- Scorisagola MIM in 17.4PH + Codolo 45°
- Disponibile nei diametri: 7mm / 7,5mm

- MIM line slider in 17.4PH STAINLESS STEEL + 45° shank
- Available in diameters: 7mm / 7.5mm



KIT	COD.	EAN	€
SC. MIM 7,0mm + Cod. 45°	AE027/B45	8056138186033	
SC. MIM 7,5mm + Cod. 45°	AE027/C45	8056138186040	

- 1 - cod. AE035 Ø 8 Asso/SL
- 2 - cod. AE039 Ø 7 Vintair Predathor Cyrano
- 3 - cod. AE033 Ø 8 Vintair Predathor Sten

- Codolo asta
- Shaft tang



KIT	COD.	EAN	€
10pz	AE033	8055960725717	
10pz	AE035	8055960725724	
10pz	AE039	8055960725612	

KIT45

- 1 - cod. AE036KIT Ø 7,0 Predathor Vuoto
- 2 - cod. AE037KIT Ø 7,5 Dark Side

- Codolo e rondella con angolo a 45°, da usare con boccia di ammortizzo ø 9mm interno
- 45° angle shank and washer



KIT	COD.	EAN	€
5pz	AE036KIT	8058093689413	
5pz	AE037KIT	8058093689406	

- Scorisagola e rondella per asta Ø 7 mm
- Line slider and washer for Ø 7 mm shaft



COD.	EAN	€
AE022	8055960725580	

- Scorisagola, rondella e molla per asta Ø 8 mm
- Line slider, washer and spring for Ø 8 mm shaft



COD.	EAN	€
AE020	8055960725700	

TESSILE DYNEEMA



NEW ARRIVAL

- Ogiva tessile DYNEEMA con Sfere INOX
- Zona di aggancio rinforzata
- DYNEEMA Textile Wishbone with INOX balls
- Reinforced coupling area

COD.	EAN	€
AP043X	8056138187955	

STRONG BOCCOLE



NEW ARRIVAL

- Ogiva articolata STRONG Boccole con sfere in acciaio INOX
- Parte tessile con nodo a bandiera facilmente sostituibile
- Ideale per essere utilizzata con elastici a foro MICRO ID
- STRONG articulated wishbone Bushings with stainless steel balls
- Textile part with easily replaceable flag knot
- Ideal for use with MICRO ID hole bands

COD.	EAN	€
AP045	8056138187030	

EUREKA EASY DYNEEMA



Braccetti per ogive in tessil
Arms for textile wishbones



Ogiva DYNEEMA con sfere
Wishbone DYNEEMA with spheres



Ogiva DYNEEMA con braccetti
Wishbone DYNEEMA with arms

COD.	EAN	€
400402	8055960724994	

COD.	EAN	€
AP043	8055960725434	

COD.	EAN	€
AP044	805596072544	

EUREKA KIT

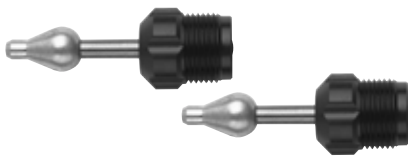

Adattatori per montare elastici al metro su testate filetatte
Adaptors to set rubbers in metres on threaded muzzles

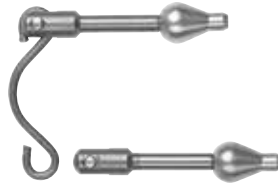

Ogiva snodata con archetto ø 2mm removibile
Articulated removable wishbones ø 2mm



Ogiva articolata con sfere per legature
Articulated wishbone with spheres

COD.	EAN	€
400401	8055960724987	

COD.	EAN	€
400406	8055960725038	

COD.	EAN	€
AP042	8055960725427	

K-VELOX



Ogiva snodata, archetto Velox
Articulated Velox

HYDRO VELOX



Ogiva snodata con archetto ø 2mm removibile
Articulated ø2mm removable



Ogiva articolata con boccole in nylon
Articulated wishbone with nylon threaded plugs

COD.	EAN	€
400408	8057685550759	

COD.	EAN	€
400405	8055960725021	

COD.	EAN	€
AP041	8055960725410	



Kit Ogive TWIN con boccole in nylon
Wishbone kit TWIN/B with nylon threaded plugs

COD.	EAN	€
AP047	8055960725472	



Kit Ogive TWIN con sfere
Wishbone kit TWIN with spheres

COD.	EAN	€
AP047/18	8055960725502	



Ogiva BIG boccole nylon
Wishbone BIG with nylon threaded plugs

COD.	EAN	€
AP047/06	8055960725489	



Ogiva SMALL boccole nylon
Wishbone SMALL with nylon threaded plugs

COD.	EAN	€
AP047/09	8055960725496	



Ogiva BIG con sfere
Wishbone BIG with spheres

COD.	EAN	€
AP047/24	8055960725519	



Ogiva SMALL con sfere
Wishbone SMALL with spheres

COD.	EAN	€
AP047/27	8055960725526	



Ogiva ECO
Wishbone ECO

KIT	COD.	EAN	€
5pz	AP046	8055960725465	



Sfere ergonomiche per archetti tessili
Ergonomic spheres for bridles wishbones

KIT	COD.	EAN	€
Kit 10 pz	400436	8055960725090	



Kit 10 sfere per legature, filettate M4
Kit 10 spheres for timing wishbones, thread M4

KIT	COD.	EAN	€
Kit 10 pz	400435	8055960725083	
Kit 10 pz	AP048	8055960725533	



Paralyzer INOX 3 punte, lunghezza 24cm. M7
Paralyzer stainless 3 prongs, length 24cm. M7

COD.	EAN	€
AA006/B	8057685550728	



Archetto Velox
Velox wishbone

KIT	COD.	EAN	€
Kit 5 pz	400431	8055960725052	



Porta fiocina e porta arpione per boa
Harpoon and prongs holder for buoy

COD.	EAN	€
AP081	8055960726103	

SPEED MUSTAD



Fiocina base nylon 4 punte originali Mustad
4 Mustad prongs, nylon body

COD.	EAN	€
AA008/B	8055960723867	
AA008/M	8058093686870	

JET 3 PUNTE MUSTAD



Fiocina base nylon 3 punte originali Mustad
3 Mustad prongs, nylon body

COD.	EAN	€
AA021	8055960723966	
AA021M	8058093686887	

JET 5 PUNTE MUSTAD



Fiocina base nylon 5 punte originali Mustad
5 Mustad prongs, nylon body

COD.	EAN	€
AA023M	8058093686894	

SPEED



Fiocina nylon 4 punte in acciaio
temperato zincato Ø 4
4 prongs, nylon body. - Tempered and galvanized steel Ø 4

COD.	EAN	€
AA008	8055960723850	

SPEED INOX



Fiocina Inox base nylon 4 punte
in acciaio inossidabile temperato Ø 4
4 stainless prongs, nylon body. - Tempered stainless steel Ø 4

COD.	EAN	€
AA008/S	8055960723874	

JET 3



Fiocina nylon 3 punte in acciaio temperato zincato Ø 4
3 prongs, nylon body. Tempered and galvanized steel Ø 4

COD.	EAN	€
AA013	8055960723928	

JET 5



Fiocina 5 punte. Acciaio temperato zincato - Ø 4
5 prongs, nylon body. Tempered and galvanized steel Ø 4

COD.	EAN	€
AA015	8055960723942	

JET 3 INOX



Fiocina Inox base nylon 3 punte in acciaio inossidabile temperato Ø 4
3 stainless prongs, nylon body. Tempered stainless steel Ø 4

COD.	EAN	€
AA025	8055960723980	

JET 5 INOX



Fiocina Inox base nylon 5 punte in acciaio inossidabile temperato Ø 4
5 stainless prongs, nylon body. Tempered stainless steel Ø 4

COD.	EAN	€
AA027	8055960723997	

MARTIN 3 PUNTE



Martin base nylon 3 punte coniche in acciaio temperato zincato nero Ø 5
Martin 3 heavy conic prongs, nylon body in tempered and black galvanized steel Ø 5

COD.	EAN	€
AA009N	8055960723881	

MARTIN 5 PUNTE



steel Ø 5 AA011N
Martin base nylon a 5 punte coniche in acciaio temperato zincato nero Ø 5
Martin 5 heavy conic prongs, nylon body in tempered and black galvanized steel Ø 5

COD.	EAN	€
AA011N/B	8055960723904	

FIOCINA BIG



Fiocina Big inox 3 punte con 3 alette mobili in acciaio inossidabile Ø 5
Big 3 Stainless prongs with 3 movable floppers in stainless steel Ø 5

COD.	EAN	€
AA040	8055960724031	

FIOCINA ALETTE MOBILI



Fiocina inox base nylon 3 punte con 2 alette mobili in acciaio inossidabile Ø 5
3 Stainless prongs with 2 movable floppers, nylon body in stainless steel Ø 5

COD.	EAN	€
AA031N	8055960724000	

3 PUNTE PESANTI



Fiocina base nylon 3 punte pesanti in acciaio temperato zincato Ø 4.5
3 heavy prongs, nylon body in tempered and galvanized steel Ø 4.5

KIT	COD.	EAN	€
1pz	AA005	8058093689420	
20pz	AA005N	8055960723836	

4 PUNTE PESANTI



Fiocina base nylon 4 punte pesanti in acciaio temperato zincato Ø 4.5
4 heavy prongs, nylon body in tempered and galvanized steel Ø 4.5

KIT	COD.	EAN	€
1pz	AA007	8058093689437	
15pz	AA007N	8055960723843	

3 PUNTE LEGGERE



Fiocina base nylon 3 punte leggere in acciaio temperato zincato Ø 3.5
3 light prongs, nylon body in tempered and galvanized steel Ø 3.5

KIT	COD.	EAN	€
1pz	AA001	8058093689444	
30pz	AA001N	8055960723812	

4 PUNTE LEGGERE



Fiocina base nylon 4 punte leggere in acciaio temperato zincato Ø 3.5
4 light prongs, nylon body in tempered and galvanized steel Ø 3.5

KIT	COD.	EAN	€
1pz	AA003	8058093689451	
25pz	AA003N	8055960723829	

3 PUNTE PESANTI INOX



Fiocina inox base nylon 3 punte pesanti in acciaio inossidabile zincato Ø 4.5
3 stainless heavy prongs, nylon body in stainless steel Ø 4.5

COD.	EAN	€
AA033N	8055960724017	

4 PUNTE PESANTI INOX



Fiocina inox base nylon 4 punte pesanti in acciaio inossidabile Ø 4.5
4 stainless heavy prongs, nylon body in stainless steel Ø 4.5

COD.	EAN	€
AA035N	8055960724024	



COMBO
ARPIONE LAZIO
+ FIOCINA 3 LEGGERE

ARPIONE LAZIO

- Arpione con 2 alette zincato
- Harpoon with 2 steel floppers

3 PUNTE LEGGERE

- Fiocina base nylon 3 punte leggere in acciaio temperato zincato Ø 3.5
- 3 light prongs, nylon body in tempered and galvanized steel Ø 3.5



COMBO
ARPIONE CONCORD
+ FIOCINA MARTIN INOX

ARPIONE CONCORDE

- Arpione in acciaio inossidabile con 2 alette lunghe
- Harpoon stainless steel with 2 long floppers

MARTIN 5 PUNTE

- Martin base nylon a 5 punte coniche in acciaio temperato zincato nero Ø 5
- Martin 5 heavy conic prongs, nylon body in tempered and black galvanized steel Ø 5



COD.	EAN	€
COMBO001	8056138182011	

COD.	EAN	€
COMBO002	8056138182028	

ARPIONE T-REX



- Arpione doppia aletta folgore, L 160mm
- Materiale: Acciaio inossidabile 174Ph Durezza 45 HRC
- Cono integrato atto a ridurre l'attrito
- Doppia aletta dall'apertura di 130mm per una maggiore trattenuta
- Filettatura interna M7

- Double flopper harpoon, length 160mm
- Material: 174Ph stainless steel Hardness 45 HRC
- Integrated friction-reducing cone
- Double flopper with 130mm opening for greater retention
- Internal thread M7

COD.	EAN	€
AC048	8056138182615	

ARPIONE RAPTOR



- Arpione doppia aletta concorde, L 125mm
- Materiale: Acciaio inossidabile 174Ph Durezza 45 HRC
- Cono integrato atto a ridurre l'attrito
- Doppia aletta dall'apertura di 100mm per una maggiore trattenuta
- Filettatura interna M7

- Double flopper harpoon, length 125mm
- Material: 174Ph stainless steel Hardness 45 HRC
- Integrated friction-reducing cone
- Double flopper with 100mm opening for greater retention
- Internal thread M7

COD.	EAN	€
AC047	8056138182608	

MOBY



Arpione in acciaio inossidabile temperato, con 2 alette
Harpoon in tempered stainless steel with 2 floggers

COD.	EAN	€
AC050	8055960724680	

K9



Arpione Ø9mm. in acciaio inossidabile 17-4Ph aletta incassata
Harpoon Ø9mm in stainless steel 17-4Ph with single embedded flopper

COD.	EAN	€
AC010A	8055960723775	

K9 TRICUSPIDE



Arpione in acciaio inossidabile 17-4Ph punta tricuspid Una aletta incassata. Ø9mm
Harpoon Ø9mm in stainless steel 17-4Ph tricuspid tip with single embedded flopper

COD.	EAN	€
AC010B	8055960723799	

PORTOGHESE



Arpione in acciaio inossidabile con 2 alette lunghe
Harpoon in stainless steel with 2 long floggers

KIT	COD.	EAN	€
1pz	AC029S	8058093689468	
5pz	AC029	8055960724628	

PORTOGHESE 1 ALETTA



Arpione in acciaio inossidabile con 1 aletta lunga
Harpoon in stainless steel with 1 long flopper

KIT	COD.	EAN	€
1pz	AC029/1S	8058093689475	
5pz	AC029/1	8058093682292	

MARTIN



Arpione in acciaio inossidabile, punta tricuspid con 2 alette lunghe
Harpoon stainless steel, tricuspid prong with 2 long floggers

COD.	EAN	€
AC040	8055960724666	

MARTIN TRICUSPIDE



AC045

Arpione in acciaio inossidabile, punta tricuspid temperata intercambiabile con 2 alette lunghe
Tricuspid stainless steel interchangeable tempered prong harpoon with 2 long floggers

COD.	EAN	€
AC043	8055960724673	
AC045	8055960724734	

MEDIO/ALETTE SFASATE



Arpione con alette sfasate corte in acciaio inossidabile
Staggered short floppers harpoon stainless steel

KIT	COD.	EAN	€
1pz	AC033S	8058093689482	
5pz	AC033	8055960724642	

MEDIO



Arpione medio in acciaio inossidabile con 2 alette corte
Medio harpoon stainless steel with 2 short floppers

KIT	COD.	EAN	€
1pz	AC031S	8058093689499	
5pz	AC031	8055960724635	

LAZIO



Arpione con 2 alette in acciaio inossidabile
Harpoon with 2 stainless in steel floppers

KIT	COD.	EAN	€
1pz	AC005S	8058093689505	
5pz	AC005	8055960724536	

LAZIO INOX



Arpione in acciaio inossidabile con 2 alette
Harpoon in stainless steel with 2 short floppers

KIT	COD.	EAN	€
1pz	AC015S	8058093689512	
5pz	AC015	8055960724574	

MINICONCORDE



Arpione in acciaio inossidabile con 2 alette corte
Harpoon stainless steel with 2 short floppers

KIT	COD.	EAN	€
1pz	AC025S	8058093689529	
5pz	AC025	8055960724604	

CORTO



Arpione corto in acciaio inossidabile con 2 alette corte
Short harpoon stainless steel with 2 short floppers

KIT	COD.	EAN	€
1pz	AC035S	8058093689536	
5pz	AC035	8055960724659	

CONCORDE



Arpione in acciaio inossidabile con 2 alette lunghe
Harpoon stainless steel with 2 long floppers

KIT	COD.	EAN	€
1pz	AC023S	8058093689543	
5pz	AC023	8055960724598	

ALETTA CAPTURE



5 pz

Aletta a profilo scalato per aste monoaletta incassata
Scaled profile barb for shafts with single embedded barb

SHAFT	KIT	COD.	EAN	€
Ø6,25mm Ø6,50mm Ø7,00mm	5pz	AE026/A	8058093682650	

ALETTA FOLGORE



4 pz

Aletta a profilo scalato, per aste monoaletta da Ø 6,25mm / Ø 6,5 non incassate o per aste a doppia aletta Ø 6,25mm / Ø 6,50mm / Ø 7,0mm / Ø 7,5mm incassate

Scaled profile barb for Ø 6,25 / Ø 6.5mm single-barb shafts, not embedded / double barb Ø 6.25mm / Ø 6.50mm / Ø 7.0mm / Ø 7.5mm

SHAFT	KIT	COD.	EAN	€
Ø6,25mm Ø6,50mm Ø7,00mm Ø7,50mm	4pz	AE026/C	8058093682674	

ALETTA RAPTOR



5 pz

- Aletta
- Lunghezza 54mm
- Spessore 0,8
- Acciaio inox Aisi 304

- Raptor barb
- Length 54 mm
- Thickness 0.8
- Stainless steel Aisi 304

SHAFT	KIT	COD.	EAN	€
Ø6,00mm Ø6,50mm Ø7,00mm	5pz	AE026/E	8056138180161	

ALETTA PACIFIC

0,245
mm

Aletta Pacific 85mm, kit 3 pz
Pacific flopper 85mm, kit 3 pz

SHAFT	KIT	COD.	EAN	€
Ø7,00mm Ø7,50mm Ø8,00mm	3pz	400275	8055960726868	

KIT O-RING

O-ring silicone - SMALL e LARGE
Silicon O-ring SMALL and LARGE



SHAFT	KIT	COD.	EAN	€
Ø 7mm	10pz	AE054/7	8055960725250	
Ø 8mm	10pz	AE054/8	8055960725267	



Protezione in gomma a T per pale in fibra
T shape rubber protection for fiber blade

KIT	COD.	EAN	€
10mt	AP060	8055960726943	

COPRIPUNTA PER FIOCCINE



Copripunte per fiocine

Cover for pronged head

PRONGED	KIT	COD.	EAN	€
3 LIGH	10pz	AE057	8055960725274	
4 LIGHT	10pz	AE059	8055960725281	
JET 5	10pz	AE060	8055960725298	
4 HEAVY	10pz	AE061	8055960725304	
MARTIN 5	10pz	AE062	8055960725311	

APPOGGIO PER ARBALETE

Appoggio per arbalete per cintura
Arbalete support for belt



COD.	EAN	€
AE069	8055960725687	

RETE PORTAPESCI

Robusta rete di nylon portapesci, con fibbia a sgancio rapido
Strong nylon net for fish, with quick unfastening buckle



COD.	EAN	€
AE081	8055960725311	

CARICHINI

Carichino per arpioni
Universal harpoon loader



cod. AE065

Carichino universale
Universal harpoon loader



cod. AE067

KIT	COD.	EAN	€
10pz	AE065	8055960725793	
10pz	AE067	8055960725731	

PROTEZIONE PER PUNTA

Protezione per punta asta tahitiana
Protector for tahitian shaft prong



KIT	COD.	EAN	€
10pz	AE063	8055960725328	

BOCCAGLIO IN SILICONE

Boccaglio in silicone per erogatori
Silicon mouthpiece for regulators



COLOR.	COD.	EAN	€
BLACK	AE140	8055960725823	
CLEAR	AE140TR	8057685557734	

PUNTA PORTAPESCI PRO



Ø 32,5 cm

- Fuso portapesci in INOX 174Ph
- Godronatura esterna antiscivolo
- Foro centrale da 2,5mm
- Fresatura posteriore con perno ribattuto per consentire il passaggio di sagola con Ø 3,5mm

- Stainless steel fish holder 174Ph
- Non-slip outer knurling
- 2.5mm central hole
- Rear milling with riveted pin to allow the passage of a 3.5 mm Ø line

COD.	KIT	EAN	€
AE085	6pz	8056138182547	

PORTAPESCI CON PORTAFUSO



- Portapesci cavetto nylon e portafuso per cintura

- Fish holder with knuckle belt



COD.	COLOR	EAN	€
AE078	Black	8055960725663	
AE078G	Acid Green	8056138181571	
AE078MG	Military Green	8056138181588	
AE078R	Red	8056138181564	
AE078W	White	8056138181595	

MULTITOOL



Multitool per assemblaggio ogive su elastico
Multitool to assemble wishbones on slings

COD.	EAN	€
AP040	8055960725403	

CARICHINO MULTILOADER



Carichino Multiloader
Multiloader

COD.	EAN	€
AE068	8055960726080	

PORTAPESCI



AE080

Portapesci con cavetto in nylon
Fish holder with nylon line

KIT	COD.	EAN	€
	AE079	8055960725670	
6pz	AE080	8055960725304	

KIT COPPER SLEEVES



Kit 25/500 pezzi copper sleeves
25/500 pc. kit copper sleeves

Ø	KIT	COD.	EAN	€
1,6	25	AP051	8055960725649	
2,3	25	AP051/2	8055960725656	
1,6	500	400270/16	8055960726936	
2,3	500	400270/23	8055960726929	

ANELLO PORTAPESCI

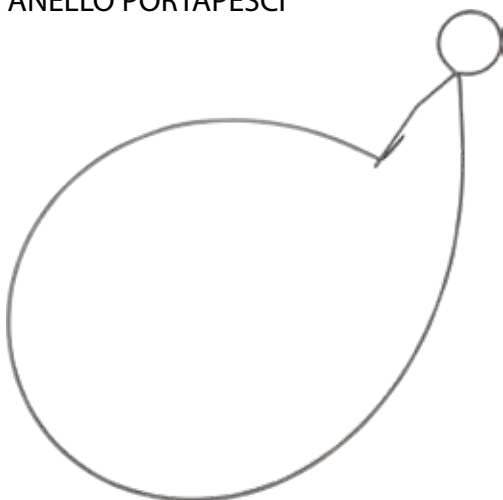

Anello portapesci in filo d'acciaio inossidabile armonico da Ø 3mm
Progettato per essere agganciato sotto la boa segnasub
Aggancio rapido

Fish holder ring in prestressed stainless-steel wire Ø 3mm
Designed to be hooked under the sub signalling buoy
Quick fastening

COD.	EAN	€
AE082	8056138182462	

MOSCHETTONE INOX



Moschettone inox
Snap clip stainless steel

AP070/20

AP070/26

AP070/30

AP070/35

MAX LOAD CAPACITY	Ø	LENGHT	KIT	COD.	EAN	€
50	2,0mm	80 mm	5 pz	AP070/20	8055960725557	
100	2,6mm	100mm	5 pz	AP070/26	8055960725564	
150	3,0mm	100mm	3 pz	AP070/30	8057685559042	
200	3,5mm	125mm	2 pz	AP070/35	8057685559059	

SHAKER AVVISATORE ACUSTICO



Shaker avvisatore acustico
Shaker

COD.	EAN	€
AP031	8055960725397	

ADATTATORE M6 / M7



Adattatore filettatura femmina, maschio M6/M7
Threaded adapter female, male M6/M7

KIT	COD.	EAN	€
10pz	AE055	8055960725694	

SNAP CLIP



Moschettone con
girella in ottone SNAP CLIP
Quick rolling SNAP - Stainless
Steel/ Pure Brass

KIT	COD.	EAN	€
5 pz	AP072	8058093684685	

NETTUNO



Nettuno con fiocina 4 punte leggera in acciaio temperato zincato diametro 3.5, corpo in nylon PA6. 1 tubo da 80cm o con 2 tubi da 60cm rivestito con guaina di protezione in plastica nera. Inserto filettato maschio M7x1

Nettuno with 4 pronged light in tempered and galvanized prongs diameter 3.5 nylon body PA6. 1 staff length 80cm or 2 staff length 60cm . with black plastic covering. Insert thread M7x1

STAFF LENGHT	COD.	EAN	€
80cm	AE001	8055960725120	
60cm x 2	AE007	8055960725137	

HUNT



Hunt con fiocina 4 punte leggera in acciaio temperato zincato diametro 3.5, corpo in nylon PA6. Asta in acciaio inox o acciaio zincato diametro 8mm. lunghezza totale 75cm. Attacco filettato maschio M7x1

Hunt with 4 pronged light head in tempered and galvanized prongs diameter 3.5 nylon body PA6. Shaft stainless steel or Galvanized steel diameter 8mm. total lenght 75cm. Connection thread M7x1

STAFF LENGHT	PROCESSING	COD.	EAN	€
75cm	GALVANIZED	AE010	8055960725144	6,20
75cm	INOX	AE012	8055960725151	8,40

RAFFI



Diametro interno Ø3,5cm
Inside diameter Ø3.5cm



Diametro interno Ø3,5cm
Inside diameter Ø3.5cm

Raffio Tana in acciaio inox, Ø 6 mm Lunghezza 70 - 50 cm
Gaff in stainless steel Ø 6 mm Lenght 70 - 50 cm

DIAMETER	LENGHT	COD.	EAN	€
6,00 mm	70cm	AE100	8055960725533	

DIAMETER	LENGHT	COD.	EAN	€
6,00 mm	50cm	AE095	8055960726097	



Diametro interno Ø7,0cm
Inside diameter Ø7,0cm



Diametro interno Ø7,0cm
Inside diameter Ø7,0cm

Raffio Barca in acciaio inox, Ø 8 mm Lunghezza 70 - 50 cm
Boat gaff in stainless steel Ø 8 mm Lenght 70 - 50cm

DIAMETER	LENGHT	COD.	EAN	€
8,00 mm	70cm	AE110	8055960725359	

DIAMETER	LENGHT	COD.	EAN	€
8,00 mm	50cm	AE105	8055960725534	



T-SHIRT SALVIMAR

NEW
ARRIVAL

OCTOPUS WHITE / NOAH GREEN

COMP.	COLOR	SIZE	COD.	EAN
140g/m ² 100% Cotton	WHITE	S	ABB021	8056138187085
	WHITE	M	ABB022	8056138187092
	WHITE	L	ABB023	8056138187108
	WHITE	XL	ABB024	8056138187115
	WHITE	XXL	ABB025	8056138187122
140g/m ² 100% Cotton	GREEN	S	ABB031	8056138187139
	GREEN	M	ABB032	8056138187146
	GREEN	L	ABB033	8056138187153
	GREEN	XL	ABB034	8056138187160
	GREEN	XXL	ABB035	8056138187177

COMP.	COLOR	SIZE	COD.	EAN
140g/m ² 100% Cotton	BLACK	S	UTPUBBL26/1	8058093689284
	BLACK	M	UTPUBBL26/2	8058093683053
	BLACK	L	UTPUBBL26/3	8058093683060
	BLACK	XL	UTPUBBL26/4	8058093683077
	BLACK	XXL	UTPUBBL26/5	8058093689291
	GREEN	S	UTPUBBL25/1	8058093682988
	GREEN	M	UTPUBBL25/2	8058093682995
	GREEN	L	UTPUBBL25/3	8058093683008
	GREEN	XL	UTPUBBL25/4	8058093683015
	GREEN	XXL	UTPUBBL25/5	8058093683022

ZIP HOODIE SALVIMAR

HOODIE SALVIMAR



COMPOSITION	COLOR	SIZE	COD.	EAN
190g/m ² 100% Cotton	DARK GRAY	S	050007C	8058093689772
	DARK GRAY	M	050007D	8058093689789
	DARK GRAY	L	050007E	8058093689796
	DARK GRAY	XL	050007F	8058093689802
	DARK GRAY	XXL	050007G	8058093689819

COMPOSITION	COLOR	SIZE	COD.	EAN
320g/m ² 93% Polyester 7% Elastane	CONVOY GRAY	S	050005C	8058093681721
	CONVOY GRAY	M	050005D	8058093681738
	CONVOY GRAY	L	050005E	8058093681745
	CONVOY GRAY	XL	050005F	8058093681752
	CONVOY GRAY	XXL	050005G	8058093681769

CAPPELLINO CON VISIERA

NEW ARRIVAL



Cappy Hat - Cappellino Salvimar con visiera - One size

CAPPY HAT BLACK

Composizione:
60% cotone
40% poliestere

CAPPY KRYPTO

Composizione:
100% poliestere

Dettagli tecnici:

- Lavare a mano utilizzando un detergente delicato
- Non candeggiare, ammolare, strofinare o strizzare
- Non asciugare in asciugatrice
- Asciugare in piano all'ombra
- Non stirare
- Non lavare a secco



Cappy Krypto Black Hat - Cappellino Kryptonite Nero con visiera - One size



Cappy Krypto Green Hat - Cappellino Kryptonite Verde Acido con visiera - One size

CAPPY HAT BLACK

Composizione:
60% cotton
40% polyester

CAPPY KRYPTO

Composizione:
100% polyester

Technical detail:

- Hand Wash with like colours using mild detergent
- Do not bleach, soak, rub or wring
- Do not tumble dry
- Dry flat in shade
- Do not iron
- Do not dry-clean

COLOR	SIZES	COD.	EAN
Black	One size	ABB010	8056138185135
Kryptonite Black	One size	ABB011	8056138185142
Kryptonite Acid Green	One size	ABB012	8056138185159

BANDIERA A VELA

STRUCTURE

Bandiera
+ Asta
+Base

SUPPORTO

Base a croce piccola
+ zavorra

SIZE

242 x 60 cm

COD.

IMBSAL070

EAN.

8058093681721



CAPPELLINO PILE



COMP:

Shell: 100% Cotton
Lining: 100% Polyester

COLOR

BLACK

SIZE

UNISEX

COD.

ABB001

EAN

8056138181809

BANNER SALVIMAR



COLOR

BLACK
ACID GREEN

SIZE

length 250cm
height 50 cm

COD.

UTPUB001A

EAN

8058093684210

€

ADESIVO



COLOR

ACID GREEN

SIZE

L 15cm - H 3 cm

COD.

UTPUB30H

€





W A T E R S P O R T S

RECORD MAN AND LADY



- Muta 2 pezzi con cappuccio incorporato e pantaloni a vita alta
- Superficie esterna in "Shark Skin" JAKO super elastica e resistente a qualsiasi tipo d'abrasione, ottima scorrevolezza negli spostamenti
- Fodera interna in "JY Aqua Stretch" con caratteristiche uniche d'elasticità e confort
- Bordi esterni in "SSRS System" a compressione graduale per massimizzare la tenuta senza costrizioni
- Chiusura coda di castoro "Beaver Tail" in velcro ripiegabile per evitare l'effetto "peeling" del tessuto
- Cucitura interna con sistema "GBS" e sigilli di tenuta su tutti gli incroci delle cuciture per una massima resistenza nei maggiori punti di tensione
- La RECORD Man viene consigliata per il Freediving e l'Apnea in acque temperate dove è fondamentale la libertà dei movimenti e la corretta ventilazione libera da costrizioni

- 2-piece wetsuit with hooded jacket and high waisted pants
- Outside surface in highly flowing "Shark Skin" JAKO, over elastic, highly flowing and non scratch material
- Inside stretch lining "JY Aqua Stretch" highly elastic and comfortable
- "SSRS System" innovative system on all the external edges
- Adjustable Velcro fastening "Beaver Tail" that can be refolded to prevent damages to the fabric
- Gluing and blind stitching system "GBS" with Melco dots sealing placed on the main pulling points for optimize the stitching strength
- The RECORD Man is recommended for Freediving in temperate waters where freedom of movement and proper ventilation free from constraints are essential



Design esclusivo Salvimar
Exclusive Salvimar design

MAN

SIZE	THICKNESS	COD.	EAN	€
S	2,5mm	000005A	8058093683459	
M	2,5mm	000005B	8058093683466	
L	2,5mm	000005C	8058093683473	
XL	2,5mm	000005D	8058093683480	
XXL	2,5mm	000005E	8058093683497	

LADY

SIZE	THICKNESS	COD.	EAN	€
XS	2,5mm	000006A	8058093683503	
S	2,5mm	000006B	8058093683510	
M	2,5mm	000006C	8058093683527	
L	2,5mm	000006D	8058093683534	
XL	2,5mm	000006E	8058093683800	

- Muta Freediving versione donna realizzata appositamente per le esigenze e specifiche richieste nell'apnea femminile
- Two pieces for freediving specifically designed for women comfort during apnea

ZEERO THERMO MAN AND LADY



- **Muta Monopezzo** spessore 1,5mm per ottimizzare ogni movimento durante il nuoto
- Neoprene "Smoothly Skin" **YAMAMOTO** di media densità con funzione di memoria elastica per rendere naturale e senza costrizione la ventilazione
- Trattamento esterno Black Coated per una migliore resistenza al contatto
- Fodera interna in U.T Super Stretch, massima compattezza abbinata ad una elasticità "Four Ways" per conformare la muta ad ogni parte del corpo
- YKK Superior #5 Cerniera professionale con cursore in metallo resistente alla corrosione
- Tenuta e resistenza ottimale, scorrimento agevolato durante la fase di chiusura/apertura
- Garanzia di ottima resistenza alle varie sollecitazioni
- "Raw Edge" finiture polsi e caviglie con sistema taglio al vivo, ottimizza la tenuta e facilita la vestizione; le caratteristiche uniche del neoprene permettono questa soluzione senza necessità di ulteriori rinforzi esterni
- La Zeero Thermo viene consigliata per il Freediving, l'Apnea e Sport Acquatici in acque temperate dove è fondamentale la libertà dei movimenti e la corretta ventilazione libera da costrizioni
- **One-piece wetsuit** 1.5mm thick to optimise every movement during swimming
- Medium density "Smoothly Skin" **YAMAMOTO** neoprene with elastic memory function to make natural and without constraint swimming and ventilation
- Black Coated external treatment for better contact resistance. Inner lining in U.T Super Stretch, maximum compactness combined with "Four Ways" elasticity to shape the wetsuit to every part of the body
- YKK Superior #5 Professional zip with salt-resistant metal slider
- Optimal sealing and resistance, easy sliding during closing/opening
- Guaranteed xcellent resistance to various stresses
- "Raw Edge" finishes on wrists and ankles with a raw cut system that optimizes the fit and ease of dressing, the unique characteristics of neoprene allow this solution without the need for additional external reinforcements
- The Zeero Thermo is recommended for Freediving and Water Sports in temperate waters where freedom of movement and proper ventilation free from constraints are essential



Caviglia con taglio specifico per agevolare la svestizione
Special cut of the ankle area to facilitate the undressing

MAN

SIZE	THICKNESS	COD.	EAN	€
S	1,5mm	000025A	8058093682384	
M	1,5mm	000025B	8058093682391	
L	1,5mm	000025C	8058093682407	
XL	1,5mm	000025D	8058093682414	
XXL	1,5mm	000025E	8058093682421	

LADY

SIZE	THICKNESS	COD.	EAN	€
XS	1,5mm	000026A	8058093682438	
S	1,5mm	000026B	8058093682445	
M	1,5mm	000026C	8058093682452	
L	1,5mm	000026D	8058093682469	
XL	1,5mm	000026E	8058093682476	
XXL	1,5mm	000026F	8056138182707	

- Muta Monopezzo LADY 1,5mm
- Versione donna con taglio preformato e anatomico
- One piece wetsuit for women, 1,5mm
- Version for ladies with preformed, anatomical cut

FLASH



- Muta Monopezzo da 1,5 mm dotata di buona elasticità e taglio anatomico performante. Il ridotto spessore enfatizza i movimenti degli arti e lo scorrimento in acqua
- Doppio tessuto "stretch nylon" per una maggiore resistenza alle abrasioni, tenuta collo in "Smooth Skin" interno, comfort e tenuta per limitare al massimo il passaggio dell'acqua durante il nuoto
- Cuciture "flatlock" per garantire elasticità e tenuta su tutti i punti di massima trazione
- Cerniera professionale "YKK Superior" con cursore in metallo
- One piece 1.5 mm wet suit. Good elasticity and high performing anatomical fit. Reduced thickness to make the swimmer's movements easier and allow the swimmer to glide through the water
- Double stretch nylon fabric for improved resistance to scratching, neck seal with "Smooth Skin" inside, comfort and seal to minimise the amount of water that gets into the suit while swimming
- "Flatlock" seams for guaranteed elasticity and seal at all points of maximum traction
- "YKK Superior" professional zipper with metal zip pull



Design esclusivo Salvimar
Exclusive Salvimar design

MAN

SIZE	THICKNESS	COD.	EAN	€
S	1,5mm	000020A	8058093680069	
M	1,5mm	000020B	8058093680076	
L	1,5mm	000020C	8058093680083	
XL	1,5mm	000020D	8058093680090	
XXL	1,5mm	000020E	8058093680106	



CARIBE



- Muta in Neoprene Q-FOAM da 3mm bifoderato mixed
- Fodera mixed Ultratender e Aquastretch massima elasticità ed ottimo comfort sulla pelle
- Monopezzo senza cappuccio
- Dedicata per immersioni in acque calde, snorkeling, nuoto e sport acquatici
- Parte frontale torace in neoprene fine mesh per una rapida asciugatura
- Cerniera posteriore con cursore in metallo anticorrosione
- Fodera superelastica zona toracica
- Chiusura collo regolabile con velcro
- Aquastretch su polsi e caviglie facilita la vestizione ed impedisce infiltrazioni di acqua
- Temperatura acqua consigliata > 21° C - 69,8° F

- Q-FOAM 3mm mixed double-lined Neoprene wetsuit
- Mixed Ultratender and Aquastretch lining maximum elasticity and excellent comfort on the skin
- One-piece without hood
- For diving in warm water, snorkelling, swimming and water sports
- Neoprene fine mesh on the chest for quick drying
- Zipper on the back with anti-corrosion metal slider
- Super-elastic lining in the chest area
- Adjustable neck closure with Velcro
- Aquastretch on the cuffs and ankles makes it easier to put on and prevents water infiltration
- Recommended water temperature > 21° C - 69,8° F



CARIBE MAN BLUE

SIZE	THICKNESS	COD.	EAN	€
S	3,0 mm	MWS00302	8056138186576	
M	3,0 mm	MWS00303	8056138186583	
L	3,0 mm	MWS00304	8056138186590	
XL	3,0 mm	MWS00305	8056138186606	
XXL	3,0 mm	MWS00306	8056138186613	

CARIBE LADY LIGHT BLUE

SIZE	THICKNESS	COD.	EAN	€
XS	3,0 mm	MWS00351	8056138188358	
S	3,0 mm	MWS00352	8056138188365	
M	3,0 mm	MWS00353	8056138188372	
L	3,0 mm	MWS00354	8056138188389	
XL	3,0 mm	MWS00355	8056138188396	

AVAILABLE 2024



CARIBE MAN YELLOW

SIZE	THICKNESS	COD.	EAN	€
S	3,0 mm	MWS00312	8056138186637	
M	3,0 mm	MWS00313	8056138186644	
L	3,0 mm	MWS00314	8056138186651	
XL	3,0 mm	MWS00315	8056138186668	
XXL	3,0 mm	MWS00316	8056138188341	

CARIBE LADY PURPLE

SIZE	THICKNESS	COD.	EAN	€
XS	3,0 mm	MWS00361	8056138188402	
S	3,0 mm	MWS00362	8056138188419	
M	3,0 mm	MWS00363	8056138188426	
L	3,0 mm	MWS00364	8056138188433	
XL	3,0 mm	MWS00365	8056138188440	

SURF SHELL

AVAILABLE 2024

NEW
ARRIVAL

- Muta short in neoprene da 2 mm bifoderato in nylon superelastico
- Monoprezzo senza cappuccio, maniche e pantaloni corti
- Ideale per snorkeling, nuoto, acque tropicali e sport acquatici
- Parte frontale torace in neoprene fine mesh per una rapida asciugatura
- Cerniera posteriore
- Chiusura collo regolabile con velcro
- Temperatura acqua consigliata > 22°C – 71,6° F
- Short wetsuit in 2 mm neoprene double lined in super-elastic nylon
- One-piece without hood, short sleeves and pants
- Ideal for snorkelling, swimming, tropical waters and water sports
- Neoprene fine mesh on the chest for quick drying
- Zipper on the back
- Adjustable neck closure with Velcro
- Recommended water temperature > 22° C – 71.6° F

ADULTsize



SURF SHELL MAN

SIZE	THICKNESS	COD.	EAN	€
S	2 mm	MWS00202	8056138186477	
M	2 mm	MWS00203	8056138186484	
L	2 mm	MWS00204	8056138186491	
XL	2 mm	MWS00205	8056138186507	
XXL	2 mm	MWS00206	8056138186514	

SURF SHELL LADY

SIZE	THICKNESS	COD.	EAN	€
XS	2 mm	MWS00211	8056138186521	
S	2 mm	MWS00212	8056138186538	
M	2 mm	MWS00213	8056138186545	
L	2 mm	MWS00214	8056138186552	
XL	2 mm	MWS00215	8056138186569	



- Muta short in neoprene 2mm bifoderato
- Monopezzo senza cappuccio, maniche e pantaloni corti
- Ideale per snorkeling ed attività acquatiche
- Cerniera frontale per una facile vestizione
- Temperatura acqua consigliata > 22°C - 71,6° F
- Short wetsuit in 2 mm neoprene double lined
- One-piece without hood, short sleeves and pants
- Ideal for snorkelling and water activities
- Front zipper for easy dressing
- Recommended water temperature > 22° C - 71.6° F

ADULTsize



AQUATIC MAN

SIZE	THICKNESS	COD.	EAN	€
S	2 mm	MWS00102	8056138186378	
M	2 mm	MWS00103	8056138186385	
L	2 mm	MWS00104	8056138186392	
XL	2 mm	MWS00105	8056138186408	
XXL	2 mm	MWS00106	8056138186415	

AQUATIC LADY

SIZE	THICKNESS	COD.	EAN	€
XS	2 mm	MWS00111	8056138186422	
S	2 mm	MWS00112	8056138186439	
M	2 mm	MWS00113	8056138186446	
L	2 mm	MWS00114	8056138186453	
XL	2 mm	MWS00115	8056138186460	

SHORTY



- Taglio anatomico
- Cerniera posteriore verticale con laccio di chiusura
- Spessore garantito 2,5 mm
- Nylon elastico esterno-interno
- Fine mesh sul torace per una rapida asciugatura
- Doppia cucitura piatta ultra resistente

- Anatomic cut
- Vertical back zipper with webbing tape
- Guaranteed thickness 2,5 mm
- Inner - Outer Nylon stretch fabric
- Fine mesh on chest for a quick drying
- High resistant flat lock stitching



SHORTY MAN

SIZE	COD.	EAN	€
S	000030A	8057685557949	
M	000030B	8057685557956	
L	000030C	8057685557963	
XL	000030D	8057685557970	
XXL	000030E	8057685557987	

SHORTY MAN

SIZE	COD.	EAN	€
XS	000031A	8057685557994	
S	000031B	8057685558007	
M	000031C	8057685558014	
L	000031D	8057685558021	
XL	000031E	8057685558038	

RASH GUARD



- Nylon 80% - Spandex 20%
- Protezione raggi ultravioletti 50⁺
- Taglio anatomico
- Striscia interna in neoprene liscio per una migliore aderenza

- Nylon 80% - Spandex 20%.
- UV protection 50⁺
- Anatomic cut
- Inner smooth neoprene strip for a better grip



BLACK & ACID GREEN - MAN

SIZE	COD.	EAN	€
S	000040A	8057685558045	
M	000040B	8057685558052	
L	000040C	8057685558069	
XL	000040D	8057685558076	
XXL	000040E	8057685558083	

BLACK & YELLOW - LADY

SIZE	COD.	EAN	€
XS	000041A	8057685558090	
S	000041B	8057685558106	
M	000041C	8057685558113	
L	000041D	8057685558120	
XL	000041E	8057685558137	

OASI RASH GUARD SHORT SLEEVE

AVAILABLE 2024

NEW ARRIVAL



- Rash Guard in tessuto con protezione UPF +50, protegge dai raggi UV
- Ideale per snorkeling e sport acquatici
- Protegge dal sole, abrasioni e dal contatto con animali marini urticanti
- Materiale super elastico mixed Spandex conferisce ottima vestibilità
- Rash Guard made of fabric with UPF +50 protection, protects from UV rays
- Ideal for snorkelling and water sports
- Protects from sun, abrasions and contact with stinging marine animals
- Super stretchy mixed Spandex material gives excellent fit



BLACK & BLUE



BLACK & GREY



BLACK & WHITE



BLACK & PINK

BLACK & BLUE - MAN

SIZE	THICKNESS	COD.	EAN	€
S		ASN00112	8056138186170	
M		ASN00113	8056138185692	
L		ASN00114	8056138185685	
XL		ASN00115	8056138185678	
XXL		ASN00116	8056138185326	

BLACK & GREY - MAN

SIZE	THICKNESS	COD.	EAN	€
XS		ASN00122	8056138185319	
S		ASN00123	8056138185302	
M		ASN00124	8056138185296	
L		ASN00125	8056138185289	
XL		ASN00126	8056138185272	

BLACK & WHITE - LADY

SIZE	THICKNESS	COD.	EAN	€
XS		ASN00151	8056138185081	
S		ASN00152	8056138185074	
M		ASN00153	8056138184985	
L		ASN00154	8056138184978	
XL		ASN00155	8056138184886	

BLACK & PINK - LADY

SIZE	THICKNESS	COD.	EAN	€
S		ASN00141	8056138185180	
M		ASN00142	8056138185173	
L		ASN00143	8056138185166	
XL		ASN00144	8056138185128	
XXL		ASN00145	8056138185111	

OASI RASH GUARD LONG SLEEVE

AVAILABLE 2024

NEW
ARRIVAL

- Rash Guard in tessuto con protezione UPF +50, protegge dai raggi UV
- Ideale per snorkelling e sport acquatici
- Protegge dal sole, abrasioni e dal contatto con animali marini urticanti
- Materiale super elastico mixed Spandex conferisce ottima vestibilità
- Rash Guard made of fabric with UPF +50 protection, protects from UV rays
- Ideal for snorkelling and water sports
- Protects from sun, abrasions and contact with stinging marine animals
- Super stretchy mixed Spandex material gives excellent fit

ADULTsize



BLACK & BLUE - MAN

SIZE	THICKNESS	COD.	EAN	€
S		ASN00102	8056138186255	
M		ASN00103	8056138185210	
L		ASN00104	8056138186286	
XL		ASN00105	8056138185203	
XXL		ASN00106	8056138185197	



BLACK & PINK - LADY

SIZE	THICKNESS	COD.	EAN	€
XS		ASN00131	8056138185265	
S		ASN00132	8056138185258	
M		ASN00133	8056138185241	
L		ASN00134	8056138185234	
XL		ASN00135	8056138185227	

OASI RASH GUARD LONG SLEEVE

AVAILABLE 2024

NEW
ARRIVAL



- Rash Guard in tessuto con protezione UPF +50, protegge dai raggi UV
- Ideale per snorkeling e sport acquatici
- Protegge dal sole, abrasioni e dal contatto con animali marini urticanti
- Materiale super elastico mixed Spandex conferisce ottima vestibilità

- Rash Guard made of fabric with UPF +50 protection, protects from UV rays
- Ideal for snorkelling and water sports
- Protects from sun, abrasions and contact with stinging marine animals
- Super stretchy mixed Spandex material gives excellent fit



WHITE & LIGHT BLUE - CHILD

SIZE	THICKNESS	COD.	EAN	€
6		ASN00162	8056138184626	
8		ASN00163	8056138184442	
10		ASN00164	8056138184060	
12		ASN00165	8056138183919	

WHITE & PINK - GIRL

SIZE	THICKNESS	COD.	EAN	€
6		ASN00172	8056138183896	
8		ASN00173	8056138183735	
10		ASN00174	8056138186163	
12		ASN00175	8056138182752	

FREE SWIM MAN & LADY

NEW
ARRIVAL

Muta Monoprezzo 2,0 mm adatta per nuoto in acque libere ed allenamento, dotata di ottima elasticità e comfort elevato

- Neoprene "Smoothly Skin" **JAKO** con funzione elastica per agevolare i movimenti durante il nuoto e la ventilazione
- Fodera interna in "stretch nylon", elastica e compattante
- Superficie esterna in "HP Super Coated" super elastico, posizionata su avambracci collo e polpacci, ottima resistenza alle abrasioni
- "JY Aqua stretch" fodera interna posizionata nella zona ascelle, braccia e polpacci, caratteristiche uniche in termini di elasticità e scorrevolezza durante la vestizione
- Cerniera professionale "YKK Superior" con cursore in metallo

2.0 mm one-piece wetsuit suitable for swimming in open water and training, with excellent elasticity and high comfort.

- **JAKO** "Smoothly Skin" neoprene with stretch function for ease of movement during swimming and ventilation
- Inner lining in "stretch nylon", elastic and compact
- Outer surface with super elastic "HP Super Coated" lining, positioned on forearms neck and calves, excellent abrasion resistance
- "JY Aqua stretch" inner lining positioned in the armpits, arms and calves area, unique characteristics in terms of elasticity and smoothness during dressing
- Professional "YKK Superior" zipper with metal slider

**DOUBLE NECK**

Tenuta al collo con due inserti di neoprene Smooth Skin accoppiato, massima efficacia nell'aderenza senza rinunciare al comfort

Neck tight fit with two coupled Smooth Skin neoprene inserts, maximum effectiveness in adherence without sacrificing comfort

**MAN**

SIZE	THICKNESS	COD.	EAN	€
S	2,0mm	000028A	8058093683312	
M	2,0mm	000028B	8058093683329	
L	2,0mm	000028C	8058093683336	
XL	2,0mm	000028D	8058093683343	
XXL	2,0mm	000028E	8058093688430	

LADY

SIZE	THICKNESS	COD.	EAN	€
XS	2,0mm	000029A	8058093688447	
S	2,0mm	000029B	8058093688454	
M	2,0mm	000029C	8058093688461	
L	2,0mm	000029D	8058093688478	
XL	2,0mm	000029E	8058093688485	

- Muta Monoprezzo LADY 2,0 mm.
- Versione donna con taglio preformato e anatomico.

- One piece wetsuit for women, 2,0mm.
- Version for ladies with preformed, anatomical cut.



- Progettata per nuoto in acque libere ed allenamento
- Neoprene ad alte prestazioni **YAMAMOTO 39** spessore 2,0 mm
- Fodera interna mixed Ultratender e Aquastretch conferiscono massimo comfort ed elasticità
- Il colore verde fluo delle maniche offre un'ottima visibilità in superficie
- Polsi e caviglie in Smoothskin Ultratender facilita la vestizione ed impedisce infiltrazioni di acqua
- Cucitura flatlock con filo superelastico
- Cerniera con cursore in metallo resistente alla corrosione

- Designed for open water swimming and training
- **YAMAMOTO 39** high-performance neoprene 2.0 mm thick
- Mixed Ultratender and Aquastretch inner lining provide for maximum comfort and elasticity
- The neon green colour of the sleeves provides excellent surface visibility
- Cuffs and ankles in Ultratender Smoothskin make it easier to put on and prevents water infiltration
- Flatlock stitching with super-elastic thread
- Zipper with corrosion-resistant metal slider



MAN

SIZE	THICKNESS	COD.	EAN	€
S	2,0mm	MWS00402	8056138186675	
M	2,0mm	MWS00403	8056138186682	
L	2,0mm	MWS00404	8056138186699	
XL	2,0mm	MWS00405	8056138186705	
XXL	2,0mm	MWS00406	8056138186712	

LADY

SIZE	THICKNESS	COD.	EAN	€
XS	2,0mm	MWS00411	8056138186729	
S	2,0mm	MWS00412	8056138186736	
M	2,0mm	MWS00413	8056138186743	
L	2,0mm	MWS00414	8056138186750	
XL	2,0mm	MWS00415	8056138186767	

- Muta Monopezzo LADY 2,0 mm.
- Versione donna con taglio preformato e anatomico.

- One piece wetsuit for women, 2,0mm.
- Version for ladies with preformed, anatomical cut.



- Maglietta girocollo in neoprene da 2.0 mm dalle molteplici funzioni
- Consigliata per tutte l'attività marine di superficie e come eventuale sotto-muta
- Estremamente elastica "Hyper Stretch" e confortevole con taglio anatomico performante
- Fodera elastica in Ultra Tender - Neoprene CR /Q foam - Aqua stretch all'interno
- Striscia in neoprene liscio su bordo maglietta "Bottom Grip" per una migliore aderenza e tenuta
- Manica ripiegata "doppio-bordo" per aumentare la tenuta
- 2.0 mm neoprene crew neck t-shirt with multiple functions
- Recommended for all surface marine activities and as a possible under-suit.
- Extremely elastic "Hyper Stretch" and comfortable with high-performance comfort contoured cut.
- Elastic lining in Ultra Tender - Neoprene CR /Q foam - Aqua stretch inside.
- Smooth neoprene strip on the edge of the "Bottom Grip" t-shirt for better adherence and tightness.
- "Double-edged" folded sleeve to increase tightness.



SIZE	THICKNESS	COD.	EAN	€
S	2,0mm	MWS01102	8056138186774	
M	2,0mm	MWS01103	8056138186781	
L	2,0mm	MWS01104	8056138186798	
XL	2,0mm	MWS01105	8056138186804	
XXL	2,0mm	MWS01106	8056138186811	

SWIM SKIN

**SWIM SKIN Man**

- Sottomuta performante con cappuccio, spessore 2,0 mm
- Smooth Skin esterno per facilitare la vestizione e la tenuta termica, accessorio fondamentale per il nuoto in acque libere in ogni stagione, da usare singolarmente nei periodi caldi oppure come sottomuta con cappuccio negli altri periodi.
- Previene l'infiltrazione d'acqua nel collo se abbinato a monopezzi da nuoto tipo ZEERO THERMO e FREE SWIM

SWIM SKIN Lady

- Stesse caratteristiche della versione Uomo con l'aggiunta di un taglio particolarmente performante, adatto alla figura femminile

SWIM SKIN Man

- High-performance undersuit with hood, 2.0 mm thick
- Outer Smooth Skin for easy dressing and thermal tightness, an essential accessory for swimming in open water in all seasons, to be used individually in warm weather or as a hooded undersuit in other periods
- Prevents water infiltration into the neck when combined with swimming one-pieces such as ZEERO THERMO and FREE SWIM

SWIM SKIN Lady

- Same features of the Men's version with the addition of a particularly performing cut, suitable for the female figure

MAN

SIZE	THICKNESS	COD.	EAN	€
S	2,0mm	ACNEO0120	8056138181816	
M	2,0mm	ACNEO0130	8056138181823	
L	2,0mm	ACNEO0140	8056138181830	
XL	2,0mm	ACNEO0150	8056138181847	
XXL	2,0mm	ACNEO0160	8056138181854	

LADY

SIZE	THICKNESS	COD.	EAN	€
XS	2,0mm	ACNEO0210	8056138181861	
S	2,0mm	ACNEO0220	8056138181878	
M	2,0mm	ACNEO0230	8056138181885	
L	2,0mm	ACNEO0240	8056138181892	
XL	2,0mm	ACNEO0250	8056138181908	

HYDRO CAP



- Cuffietta nuoto con sottotondo di tenuta, realizzata in neoprene 3,5 mm superelastico per il nuoto in acque libere con temperature tra 10 e 22°
- Protezione termica assoluta, accuratamente designata per seguire la forma della testa e in particolar modo dell'orecchie evitando fastidiose costrizioni.
- Swimming cap with under-chin seal, made of 3.5 mm super-elastic neoprene for swimming in open water with temperatures between 10 and 22°
- Absolute thermal protection, carefully designed to follow the shape of the head and especially of the ears, avoiding annoying constraints

SIZE	THICKNESS	COD.	EAN	€
S	3,5mm	ACNEO0320	8056138181915	
M	3,5mm	ACNEO0330	8056138181922	
L	3,5mm	ACNEO0340	8056138181939	

SWIM SOCKS



- Calzare 2,0 mm in Smooth Skin esterno estremamente confortevole ed elastico
- Accessorio fondamentale per aumentare il comfort, dove si richiede un aumento della tenuta termica
- Suola rinforzata, taglio anatomico con estensione fino al sotto- ginocchio
- Consigliato per il nuoto in acque libere nel periodo autunno/inverno
- 2.0 mm sock in extremely comfortable and elastic outer Smooth Skin
- Essential accessory to increase comfort, where an increase in thermal sealing is required
- Reinforced sole, anatomical cut with extension up to below the knee
- Recommended for open water swimming in autumn/winter

SIZE	THICKNESS	COD.	EAN	€
S	2,0 mm	CAL00120	8056138181946	
M	2,0 mm	CAL00130	8056138181953	
L	2,0 mm	CAL00140	8056138181960	
XL	2,0 mm	CAL00150	8056138181977	
XXL	2,0 mm	CAL00160	8056138181984	

SWIMMY SAFE BAG



ORANGE

- Boa multifunzionale gonfiabile con capiente sacca stagna interna. Nei colori Giallo e Arancio Fluo ad alta visibilità
- Laccio di trasporto in acqua regolabile con clip
- Spallacci esterni regolabili con moschettoni per il trasporto a spalle o tradizionale
- Valvola di sicurezza/gonfiaggio ad alto flusso con sistema rapido di chiusura/apertura

- Inflatable multifunctional buoy with large inner watertight bag. In high visibility Yellow and Orange Fluo colours.
- Adjustable water-carrying strap with clip
- Adjustable outer shoulder straps with snap hook for shoulder or traditional carrying
- High-flow safety/inflation valve with quick closing/opening system

LT	COLOR	COD.	EAN	€
20	ORANGE	4005420	8056138182653	
20	YELLOW	400542Y	8056138182660	

SWIMMY SAFE



- Boa nuoto Orange Fluo ad alta visibilità per ogni performance di nuoto in sicurezza, laccio di trasporto in acqua regolabile con clip, Valvola di sicurezza/gonfiaggio con sistema rapido di chiusura/apertura

- Orange Fluo swimming buoy with high visibility for every safe swimming performance, adjustable water-carrying strap with clip, Safety/inflation valve with quick closing/opening system

LT	COLOR	COD.	EAN	€
15	ORANGE	400540	8056138182646	





S N O R K E L I N G



CORAL



- Dispositivo di protezione individuale D.P.I. EN 16805:2015
- Facciale 100% silicone, ipoallergenico di alta qualità
- Ampio campo visivo
- Vetro monoculare temperato ed ultrasensibile
- Cinturino regolabile in silicone
- Fibbia con regolazione micrometrica
- Design e concetto tecnico made in Salvimar

- Personal protective equipment PPE EN 16805:2015
- 100% high-quality, hypoallergenic silicone facepiece
- Wide field of vision
- Tempered, highly resistant monocular glass
- Adjustable silicone strap
- Micrometrically adjustable buckle
- Design and technical concept made in Salvimar



BLUE - CLEAR



RED - CLEAR



► Suggested Pack: 12 pz

WEIGHT	COLOR	COD.	EAN	€
192,00gr.	YELLOW - PETROL	SN011	8056138183483	
192,00gr.	BLUE - CLEAR	SN012	8056138183490	
192,00gr.	RED - CLEAR	SN010	8056138183476	

NEO



- Dispositivo di protezione individuale D.P.I. EN 16805:2015
- Maschera di concezione Frameless
- Facciale 100% silicone, ipoallergenico di alta qualità
- Ampio campo visivo
- Vetro monoculare temperato ed ultraresistente
- Cinturino regolabile in silicone
- Fibbia con regolazione micrometrica
- Design e concetto tecnico made in Salvimar

- Personal protective equipment PPE EN 16805:2015
- Frameless design mask
- 100% high-quality, hypoallergenic silicone facepiece
- Wide field of vision
- Tempered, highly resistant monocular glass
- Adjustable silicone strap
- Micrometrically adjustable buckle
- Design and technical concept made in Salvimar



WHITE



BLACK



► Suggested Pack: 12 pz

WEIGHT	COLOR	COD.	EAN	€
170,00gr.	PETROL	SN051	8056138182806	
170,00gr.	WHITE	SN050	8056138182790	
170,00gr.	BLACK	7300BB	8057685559325	

MORPHEUS



- Dispositivo di protezione individuale D.P.I. EN 16805:2015
- Facciale 100% silicone, ipoallergenico di alta qualità
- Ampio campo visivo
- Vetro bioculare temperato ed ultraresistente
- Cinturino regolabile in silicone
- Fibbia con regolazione micrometrica
- Design e concetto tecnico made in Salvimar

- Personal protective equipment PPE EN 16805:2015
- 100% high-quality, hypoallergenic silicone facepiece
- Wide field of vision
- Tempered, highly resistant binocular glass
- Adjustable silicone strap
- Micrometrically adjustable buckle
- Design and technical concept made in Salvimar



YELLOW - CLEAR



SHINING BLUE



► Suggested Pack: 12 pz

WEIGHT	COLOR	COD.	EAN	€
150,00gr.	YELLOW - CLEAR	000060G	8058093680724	
150,00gr.	BLUE - CLEAR	000060BL	8058093680717	
150,00gr.	SHINING BLUE	000060SB	8056138182837	

TRINITY



- Dispositivo di protezione individuale D.P.I. EN 16805:2015
- Facciale 100% silicone, ipoallergenico di alta qualità
- Ampio campo visivo
- Vetro bioculare temperato ed ultrasensibile
- Cinturino regolabile in silicone
- Fibbia con regolazione micrometrica
- Predisposizione per "Action Cam" subacquee
- Design e concetto tecnico made in Salvimar

- Personal protective equipment PPE EN 16805:2015
- 100% high-quality, hypoallergenic silicone facepiece
- Wide field of vision
- Tempered, highly resistant binocular glass
- Adjustable silicone strap
- Micrometrically adjustable buckle
- Compatible with underwater Action Cams
- Design and technical concept made in Salvimar



BLACK - BLACK



► Suggested Pack: 12 pz

WEIGHT	COLOR	COD.	EAN	€
172,00gr	BLUE - CLEAR	000061BL	8058093680731	
172,00gr	BLACK - BLACK	7500BB	8058093680649	

INCREDIBLE

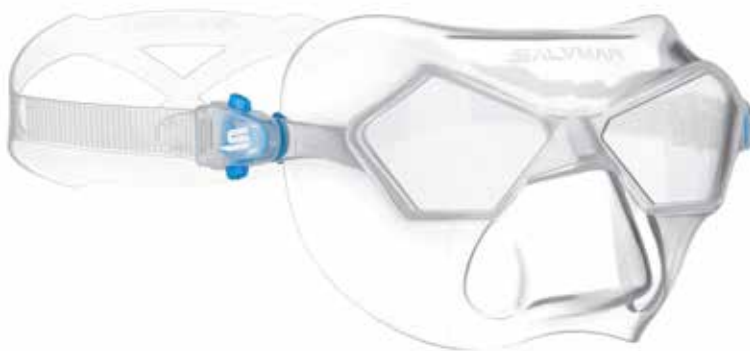

- Dispositivo di protezione individuale D.P.I. EN 16805:2015
- Maschera di concezione "Minimal" ultra compatta e leggera
- Facciale 100% silicone, ipoallergenico di alta qualità
- Ampio campo visivo
- Lenti antifog in policarbonato
- Cinturino regolabile in silicone
- Fibbia con regolazione micrometrica
- Disegno e Concetto Tecnico sviluppato in Salvimar

- Personal protective equipment PPE EN 16805:2015
- Ultra-compact and lightweight "Minimal" design
- 100% high-quality, hypoallergenic silicone facepiece
- Wide field of vision
- Antifog lens in polycarbonate
- Adjustable silicone strap
- Micrometrically adjustable buckle
- Design and technical concept made in Salvimar



BLUE - CLEAR



BLUE - WHITE



CLEAR - BLACK

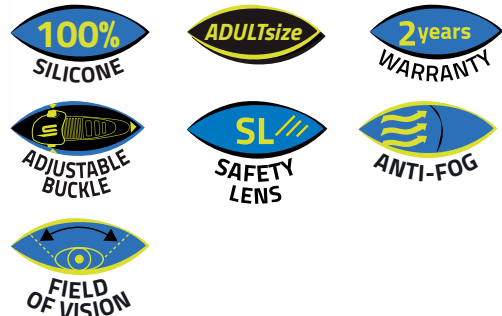

► Suggested Pack: 24 pz

WEIGHT	COLOR	COD.	EAN	€
60,00gr.	CLEAR - CLEAR	000078B	8058093684074	
60,00gr.	BLUE - CLEAR	000078A	8058093684081	
60,00gr.	BLUE - WHITE	000078G	8058093685422	
60,00gr.	CLEAR - BLACK	000078E	8058093684067	

MORPHEUS MID

AVAILABLE 2024

NEW ARRIVAL



- Dispositivo di protezione individuale D.P.I. EN 16805:2015
- Facciale 100% silicone, ipoallergenico di alta qualità
- Ampio campo visivo
- Vetro bioculare temperato ed ultraresistente
- Cinturino regolabile in silicone
- Fibbia con regolazione micrometrica
- Design e concetto tecnico made in Salvimar

- Personal protective equipment PPE EN 16805:2015
- 100% high-quality, hypoallergenic silicone facepiece
- Wide field of vision
- Tempered, highly resistant binocular glass
- Adjustable silicone strap
- Micrometrically adjustable buckle
- Design and technical concept made in Salvimar



TRANSPARENT - AQUAMARINE/CLEAR



► Suggested Pack: 12 pz

WEIGHT	COLOR	COD.	EAN	€
96,00gr	PETROL - PETROL/YELLOW	SN082	8056138189089	
96,00gr	TRANSPARENT - AQUAMARINE/CLEAR	SN083	8056138189096	

RAY



- Dispositivo di protezione individuale D.P.I. EN 16805:2015
- Facciale 100% silicone, ipoallergenico di alta qualità
- Ampio campo visivo
- Vetro monoculare temperato ed ultraresistente
- Cinturino regolabile in silicone
- Fibbia con regolazione micrometrica
- Design e concetto tecnico made in Salvimar

- Personal protective equipment PPE EN 16805:2015
- 100% high-quality, hypoallergenic silicone facepiece
- Wide field of vision
- Tempered, highly resistant monocular glass
- Adjustable silicone strap
- Micrometrically adjustable buckle
- Design and technical concept made in Salvimar



BLACK - TRANSPARENT PINK - CLEAR



YELLOW - PETROL - CLEAR



► Suggested Pack: 12 pz

WEIGHT	COLOR	COD.	EAN	€
173,00gr.	BLACK - TRANSPARENT LIME - CLEAR	SN020	8056138182875	
173,00gr.	BLACK - TRANSPARENT PINK - CLEAR	SN021	8056138183506	
173,00gr.	YELLOW - PETROL - CLEAR	SN022	8056138183513	

ENDLESS



- Dispositivo di protezione individuale D.P.I. EN 16805:2015
- Maschera di concezione Frameless
- Facciale 100% silicone, ipoallergenico di alta qualità
- Ampio campo visivo
- Vetro monoculare temperato ed ultrasensibile
- Cinturino regolabile in silicone
- Fibbia con regolazione micrometrica
- Design e concetto tecnico made in Salvimar

- Personal protective equipment PPE EN 16805:2015
- Frameless design mask
- 100% high-quality, hypoallergenic silicone facepiece
- Wide field of vision
- Tempered, highly resistant monocular glass
- Adjustable silicone strap
- Micrometrically adjustable buckle
- Design and technical concept made in Salvimar



WHITE



BLACK



► Suggested Pack: 12 pz

WEIGHT	COLOR	COD.	EAN	€
160,00gr.	WHITE	SN060	8056138182813	
160,00gr.	PINK	SN061	8056138182820	
160,00gr.	BLACK	7200BB	8057685557321	

FRANCY PRO Silicone



- Dispositivo di protezione individuale D.P.I. EN 16805:2015
- Facciale 100% silicone, ipoallergenico di alta qualità
- Ampio campo visivo
- Vetro bioculare "Safety Lens", anti - fog
- Cinturino regolabile in silicone
- Fibbia con regolazione micrometrica
- Design e concetto tecnico made in Salvimar

- Personal protective equipment PPE EN 16805:2015
- 100% high-quality, hypoallergenic silicone facepiece
- Wide field of vision
- Safety Lens, binocular anti-fog glass
- Adjustable silicone strap
- Micrometrically adjustable buckle
- Design and technical concept made in Salvimar



YELLOW - CLEAR



RED - CLEAR



► Suggested Pack: 12 pz

WEIGHT	COLOR	COD.	EAN	€
135,00gr.	BLUE - CLEAR	SN031	8056138182738	
135,00gr.	YELLOW - CLEAR	SN030	8056138182721	
135,00gr.	RED - CLEAR	SN032	8056138182745	

FULL VISION



- Dispositivo di protezione individuale D.P.I. EN 16805:2015
- Facciale 100% Softil, ipoallergenico di alta qualità
- Ampio campo visivo
- Monoculare "Safety Lens", anti - fog
- Cinturino regolabile in Softil
- Fibbia con regolazione rapida

- Personal protective equipment PPE EN 16805:2015
- 100% high-quality, hypoallergenic Softil facepiece
- Wide field of vision
- "Safety Lens", monocular anti-fog
- Adjustable Softil strap
- Quick-adjust buckle



▶ Suggested Pack: 12 pz

WEIGHT	COLOR	COD.	EAN	€
165,00gr.	SOFTIL BLUE	WB0288BL	8055960725342	

VICTORIA



- Dispositivo di protezione individuale D.P.I. EN 16805:2015
- Facciale 100% Softil, ipoallergenico di alta qualità
- Ampio campo visivo
- Vetro bioculare "Safety Lens", anti - fog
- Cinturino regolabile in Softil
- Fibbia con regolazione rapida

- Personal protective equipment PPE EN 16805:2015
- 100% high-quality, hypoallergenic Softil facepiece
- Wide field of vision
- Safety Lens, binocular anti-fog glass
- Adjustable Softil strap
- Quick-adjust buckle



▶ Suggested Pack: 12 pz

WEIGHT	COLOR	COD.	EAN	€
150,00gr.	SOFTIL BLUE	WB0289BL	8057685556201	

EMILY



- Dispositivo di protezione individuale D.P.I. EN 16805:2015
- Facciale 100% Softil, ipoallergenico di alta qualità
- Ampio campo visivo
- Vetro monoculare "Safety Lens", anti - fog
- Cinturino regolabile in Softil
- Fibbia con regolazione rapida

- Personal protective equipment PPE EN 16805:2015
- 100% high-quality, hypoallergenic Softil facepiece
- Wide field of vision
- Safety Lens, monocular anti-fog glass
- Adjustable Softil strap
- Quick-adjust buckle



▶ Suggested Pack: 12 pz

WEIGHT	COLOR	COD.	EAN	€
135,00gr.	SOFTIL BLUE	WB0294BL	805768550438	

FRANCY



- Dispositivo di protezione individuale D.P.I. EN 16805:2015
- Facciale 100% Softil, ipoallergenico di alta qualità
- Ampio campo visivo
- Vetro bioculare "Safety Lens", anti - fog
- Cinturino regolabile in Softil
- Fibbia con regolazione rapida

- Personal protective equipment PPE EN 16805:2015
- 100% high-quality, hypoallergenic Softil facepiece
- Wide field of vision
- Safety Lens, binocular anti-fog glass
- Adjustable Softil strap
- Quick-adjust buckle



▶ Suggested Pack: 12 pz

WEIGHT	COLOR	COD.	EAN	€
135,00gr.	SOFTIL BLUE	WB0249BL	8055960725342	

MILLY



- Dispositivo di protezione individuale D.P.I. EN 16805:2015
- Facciale 100% Softil, ipoallergenico di alta qualità
- Ampio campo visivo
- Vetro monoculare "Safety Lens", anti - fog
- Cinturino in Softil

- Personal protective equipment PPE EN 16805:2015
- 100% high-quality, hypoallergenic Softil facepiece
- Wide field of vision
- Safety Lens, monocular anti-fog glass
- Softil strap



▶ Suggested Pack: 12 pz



BLUE - CLEAR



YELLOW - CLEAR

WEIGHT	COLOR	COD.	EAN	€
95,00gr.	RED - CLEAR	SN042	8056138182783	
95,00gr.	BLUE - CLEAR	SN041	8056138182776	
95,00gr.	YELLOW - CLEAR	SN040	8056138182769	



COMBO SET MORPHEUS

MORPHEUS Mask + TIME SPLASH Snorkel



MORPHEUS Mask

- Dispositivo di protezione individuale D.P.I. EN 16805:2015
- Facciale 100% silicone, ipoallergenico di alta qualità
- Ampio campo visivo
- Vetro monocolare temperato ed ultrasensibile
- Cinturino in silicone con fibbia regolabile
- Design e concetto tecnico made in Salvimar



BLACK - CLEAR

TIME SPLASH Snorkel

- Boccaglio in silicone ipoallergenico
- Valvola di scarico in silicone
- Passante fissatubo regolabile
- Paraspruzzi direzionale



YELLOW - CLEAR

MORPHEUS Mask

- Personal protective equipment PPE EN 16805:2015
- 100% high-quality, hypoallergenic silicone facepiece
- Wide field of vision
- Tempered, highly resistant monocular glass
- Silicone strap with adjustable buckle
- Design and technical concept made in Salvimar

TIME SPLASH Snorkel

- Hypoallergenic silicone mouthpiece
- Silicone drain valve
- Adjustable hose clamping loop
- Directional splash guard

▶ Suggested Pack: 6 pz

COLOR	COD.	EAN	€
BLUE - CLEAR	000065BL	8058093682605	
YELLOW - CLEAR	000065G	8058093682612	
BLACK - CLEAR	000065BK	8056138184916	

COMBO SET CORAL

CORAL Mask + DORY Snorkel



CORAL Mask

- Dispositivo di protezione individuale D.P.I. EN 16805:2015
- Facciale 100% silicone, ipoallergenico di alta qualità
- Ampio campo visivo
- Vetro monocolare temperato ed ultrasensibile
- Cinturino in silicone con fibbia regolabile

DORY Snorkel

- Boccaglio in silicone ipoallergenico
- Valvola di scarico in silicone
- Passante fissatubo regolabile
- Paraspruzzi direzionale ad area maggiorata

CORAL Mask

- Personal protective equipment PPE EN 16805:2015
- 100% high-quality, hypoallergenic silicone facepiece
- Wide field of vision
- Tempered, highly resistant monocular glass
- Silicone strap with adjustable buckle

DORY Snorkel

- Hypoallergenic silicone mouthpiece
- Silicone drain valve
- Adjustable hose clamping loop
- Oversized directional splash guard

▶ Suggested Pack: 6 pz

COLOR	COD.	EAN	€
BLUE - CLEAR	SNC012	8056138182844	

COMBO SET MORPHEUS MID

MORPHEUS MID Mask + DEB Snorkel



AQUAMARINE

MORPHEUS MID Mask

- Dispositivo di protezione individuale D.P.I. EN 16805:2015
- Facciale 100% silicone, ipoallergenico di alta qualità
- Ampio campo visivo
- Vetro bioculare temperato ed ultrasensibile
- Cinturino regolabile in silicone
- Fibbia con regolazione micrometrica
- Design e concetto tecnico made in Salvimar

DEB Snorkel

- Tubo con curvatura anatomica
- Boccaglio in silicone ipoallergenico
- Valvola di scarico in silicone
- Passante fissatubo regolabile
- Paraspruzzi direzionale

MORPHEUS MID Mask

- Personal protective equipment PPE EN 16805:2015
- 100% high-quality, hypoallergenic silicone facepiece
- Wide field of vision
- Tempered, highly resistant binocular glass
- Adjustable silicone strap
- Micrometrically adjustable buckle
- Design and technical concept made in Salvimar

DEB Snorkel

- Anatomically curved tube
- Hypoallergenic silicone mouthpiece
- Silicone drain valve
- Adjustable hose clamping loop
- Directional splash guard

AVAILABLE 2024

► Suggested Pack: 6 pz

COLOR	COD.	EAN	€
PETROL / YELLOW	SNC050	8056138189140	
AQUAMARINE	SNC051	8056138189119	

COMBO SET RAY

RAY Mask + DEB Snorkel



YELLOW - PETROL - CLEAR

RAY Mask

- Dispositivo di protezione individuale D.P.I. EN 16805:2015
- Facciale 100% silicone, ipoallergenico di alta qualità
- Ampio campo visivo
- Vetro monoculare temperato ed ultrasensibile
- Cinturino in silicone con fibbia regolabile

DEB Snorkel

- Boccaglio in silicone ipoallergenico
- Valvola di scarico in silicone
- Passante fissatubo regolabile
- Paraspruzzi direzionale

RAY Mask

- Personal protective equipment PPE EN 16805:2015
- 100% high-quality, hypoallergenic silicone facepiece
- Wide field of vision
- Tempered, highly resistant monocular glass
- Silicone strap with adjustable buckle

DEB Snorkel

- Hypoallergenic silicone mouthpiece
- Silicone drain valve
- Adjustable hose clamping loop
- Directional splash guard

► Suggested Pack: 6 pz

COLOR	COD.	EAN	€
YELLOW / BLACK	SNC020	8056138183537	
NEW PETROL / YELLOW	SNC021	8056138189133	

COMBO SET FRANCY PRO

FRANCY PRO Mask + TEDDY Snorkel



YELLOW - CLEAR



FRANCY Mask

- Dispositivo di protezione individuale D.P.I. EN 16805:2015
- Facciale 100% silicone, ipoallergenico di alta qualità
- Ampio campo visivo
- Vetro bioculare "Safety Lens", anti - fog
- Cinturino in silicone con fibbia regolabile
- Design e concetto tecnico made in Salvimar

TEDDY Snorkel

- Boccaglio in silicone ipoallergenico
- Passante fissatubo regolabile
- Fascetta "Mirror" 360°, per una rapida identificazione

FRANCY Mask

- Personal protective equipment PPE EN 16805:2015
- 100% high-quality, hypoallergenic silicone facepiece
- Wide field of vision
- Safety Lens, binocular anti-fog glass
- Silicone strap with adjustable buckle
- Design and technical concept made in Salvimar

TEDDY Snorkel

- Hypoallergenic silicone mouthpiece
- Adjustable hose clamping loop
- 360° "Mirror" strap for quick identification

Suggested Pack: 6 pz

COLOR	COD.	EAN	€
BLUE - CLEAR	SNC031	8056138182868	
YELLOW - CLEAR	SNC030	8056138182851	

TIME SPLASH



- Tubo con curvatura anatomica
- Boccaglio in silicone ipoallergenico
- Valvola di scarico in silicone
- Passante fissatubo regolabile
- Paraspruzzi direzionale

- Anatomically curved tube
- Hypoallergenic silicone mouthpiece
- Silicone drain valve
- Adjustable hose clamping loop
- Directional splash guard

ADULTsize

2 years
WARRANTY

100%
SILICONE
MOUTHPIECE



YELLOW - CLEAR



BLACK - CLEAR

► Suggested Pack: 12 pz

COLOR	COD.	EAN	€
BLUE - CLEAR	000171BL	8058093680748	
YELLOW - CLEAR	000171G	8058093682162	
BLACK - CLEAR	000171BK	8056138184893	

DORY



- Tubo con curvatura anatomica
- Boccaglio in silicone ipoallergenico
- Valvola di scarico in silicone
- Passante fissatubo regolabile
- Paraspruzzi direzionale ad area maggiorata

- Anatomically curved tube
- Hypoallergenic silicone mouthpiece
- Silicone drain valve
- Adjustable hose clamping loop
- Oversized directional splash guard

ADULTsize

2 years
WARRANTY

100%
SILICONE
MOUTHPIECE



PETROL - CLEAR



CLEAR BLUE - CLEAR

YELLOW - CLEAR

► Suggested Pack: 12 pz

COLOR	COD.	EAN	€
NEW PETROL - CLEAR	SNB013	8056138189126	
BLUE - CLEAR	SNB010	8056138183568	
CLEAR BLUE - CLEAR	SNB011	8056138183544	
CLEAR YELLOW - CLEAR	SNB012	8056138183575	

DEB



- MIDsize**
- 2 years WARRANTY**
- 100% SILICONE MOUTHPIECE**

- Tubo con curvatura anatomica
- Boccaglio in silicone ipoallergenico
- Valvola di scarico in silicone
- Passante fissatubo regolabile
- Paraspruzzi direzionale
- Anatomically curved tube
- Hypoallergenic silicone mouthpiece
- Silicone drain valve
- Adjustable hose clamping loop
- Directional splash guard



AQUAMARINE - CLEAR



PETROL - CLEAR

▶ Suggested Pack: 12 pz

COLOR	COD.	EAN	€
NEW AQUAMARINE - CLEAR	SNB023	8056138189102	
PETROL - CLEAR	SNB020	8056138183582	
YELLOW - CLEAR	SNB021	8056138183599	

BITE AIR



- ADULTsize**
- 2 years WARRANTY**
- 100% SILICONE MOUTHPIECE**

- Nuovo snorkel extrasoft
- Morso anatomico in silicone anallergico per un prolungato utilizzo
- Passante fissa tubo regolabile in altezza
- Design made in Salvimar
- New Extra soft snorkel
- Anatomic mouthpiece in silicone antiallergic for prolonged use
- Adjustable height snorkel keeper
- Salvimar exclusive design



SHINNING BLUE



WHITE



BLACK

▶ Suggested Pack: 12 pz

COLOR	COD.	EAN	€
PETROL	700300P	8056138183728	
BLACK	700300B	8057685559349	
WHITE	700300W	8058093680502	
SHINNING BLUE	73005B	8056138188334	

CLASSIC



- ADULTsize**
- 2 years WARRANTY**
- SOFTIL MOUTHPIECE**

- Boccaglio in softil ipoallergenico
- Passante fissatubo regolabile
- Fascetta "Mirror" 360°, per una rapida identificazione

- Hypoallergenic Softil mouthpiece
- Adjustable hose clamping loop
- 360° "Mirror" strap for quick identification



YELLOW - CLEAR BLACK - CLEAR

▶ Suggested Pack: 12 pz

COLOR	COD.	EAN	€
BLUE - CLEAR	WB0364BL	8057685552333	
YELLOW - CLEAR	WB0364Y	8057685552340	
BLACK - CLEAR	WB0364BK	8057685552326	

TILTY



- ADULTsize**
- 2 years WARRANTY**
- SOFTIL MOUTHPIECE**

- Boccaglio in softil ipoallergenico
- Passante fissatubo regolabile
- Fascetta "Mirror" 360°, per una rapida identificazione



BLUE - BLACK BLACK - BLACK

TILTY

TILTY JR

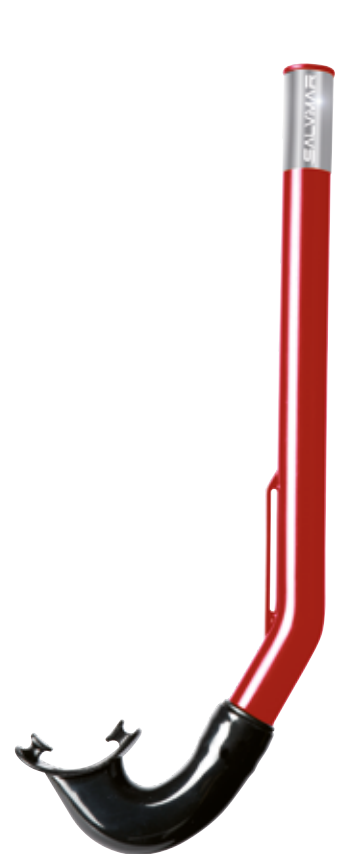

- MIDsize**
- 2 years WARRANTY**
- SOFTIL MOUTHPIECE**

- Hypoallergenic Softil mouthpiece
- Adjustable hose clamping loop
- 360° "Mirror" strap for quick identification



BLUE - BLACK

▶ Suggested Pack: 12 pz

COLOR	COD.	EAN	€
YELLOW	WB0356Y	8057685552869	
BLUE	WB0356BL	8057685558779	
BLACK	WB0356BK	8057685553569	

TILTY JR

▶ Suggested Pack: 12 pz

COLOR	COD.	EAN	€
RED	WB0350RE	8057685552852	
BLUE	WB0350BL	8057685551787	

NOBLIS



BLUE



BLACK

- Pinna da snorkeling leggera e confortevole
- Versione a scarpetta chiusa in materiale morbido e resistente
- Pala performante con ottimo ritorno elastico, ottimizza le prestazioni
- Scarpetta: Thermoflex inclinata
- Pala: P.P. ad alto grado di performance

- Light and comfortable fins, suitable for snorkeling
- Full foot pocket version in soft and high resistant material
- High performance blade with superior elastic reaction
- Full foot pocket: inclined Thermoflex
- Blade: P.P. with high performance result

NOBLIS Yellow

▶ Suggested Pack: 6 pz

SIZE	COLOR	COD.	EAN	€
34/35	YELLOW	PIN10034Y	8056138186187	
36/37	YELLOW	PIN10036Y	8056138186194	
38/39	YELLOW	PIN10038Y	8056138186200	
40/41	YELLOW	PIN10040Y	8056138186217	
42/43	YELLOW	PIN10042Y	8056138186224	

NOBLIS Blue

▶ Suggested Pack: 6 pz

SIZE	COLOR	COD.	EAN	€
34/35	BLUE	WB0400/34BL	8057685551800	
36/37	BLUE	WB0400/36BL	8057685551817	
38/39	BLUE	WB0400/38BL	8057685551824	
40/41	BLUE	WB0400/40BL	8057685551831	
42/43	BLUE	WB0400/42BL	8057685551848	
44/45	BLUE	WB0400/44BL	8057685551961	
46/47	BLUE	WB0400/46BL	8057685552098	

NOBLIS Black

▶ Suggested Pack: 6 pz

SIZE	COLOR	COD.	EAN	€
34/35	BLACK	000099A	8058093682537	
36/37	BLACK	000099B	8058093682544	
38/39	BLACK	000099C	8058093682551	
40/41	BLACK	000099D	8058093682568	
42/43	BLACK	000099E	8058093682575	
44/45	BLACK	000099F	8058093682582	
46/47	BLACK	000099G	8058093682599	

TRAINING



ADULTsize

MIDsize

2 years
WARRANTY

- Pinna corta concepita espressamente per il nuoto
- Pala reattiva e leggera per garantire una pinneggiata agile
- La conformazione della scarpetta la rende estremamente confortevole

- Short fin, specifically designed for swimming
- Reactive and light blade for quick strokes
- The footpocket shape is extremely comfortable

► Suggested Pack: 8 pz

SIZE	COLOR	COD.	EAN	€
34/35	BLUE	000096A	8057685554757	
36/37	BLUE	000096B	8057685554788	
38/39	BLUE	000096C	8057685554795	
40/41	BLUE	000096D	8057685554801	
42/43	BLUE	000096E	8057685554818	
44/45	BLUE	000096F	8057685554825	
46/47	BLUE	000096G	8057685554832	



JEKO



- Tecnologia innovativa con lenti co-stampate
- Ottimo campo visivo
- Facciale avvolgente in silicone per una massima aderenza al viso
- Nessun segno intorno agli occhi
- Fibbia con regolazione micrometrica del cinturino
- Lenti Blue, Clear e Smoked
- Lenti antifog in policarbonato
- Protezione UV
- Design e concetto tecnico made in Salvimar

- Innovative technology with co-molded lenses
- Wide visual field
- Silicone wrap-around skirt for best adherence to the face
- No marks around the eyes
- Micrometrically adjustable strap
- Blue, Clear and Smoked lens
- Antifog lens in polycarbonate
- UV protection
- Design & Technical Concept made in Salvimar



CLEAR - CLEAR



SMOKED - CLEAR



SMOKED - BLACK

► Suggested Pack: 24 pz

PACK	MATERIAL	COLOR	COD.	EAN	€
12pz	SILICONE	BLUE - CLEAR	000076A	8058093680809	
12pz	SILICONE	CLEAR - CLEAR	000076B	8058093680816	
12pz	SILICONE	SMOKED - CLEAR	000076C	8058093680823	
12pz	SILICONE	SMOKED - BLACK	000076D	8058093680830	

FREEDOM



- Occhiale nuoto piscina/mare in silicone
- Ampio campo visivo
- Super confortevole
- Fibbie a regolazione rapida
- Lenti antifog in policarbonato

- Silicone swimming pool/sea goggles
- Wide field of vision
- Super comfortable
- Quick-adjust buckles
- Polycarbonate antifog lenses



LIGHT BLUE - CLEAR



GREY - BLACK

► Suggested Pack: 12 pz

COLOR	COD.	EAN	€
YELLOW - PETROL	OCC112	8056138183797	
LIGHT BLUE - CLEAR	OCC111	8056138183490	
GREY - BLACK	OCC110	8056138183803	

FREEDOM JR



- Occhiale nuoto piscina/mare in silicone
- Ampio campo visivo
- Super confortevole
- Fibbie a regolazione rapida
- Lenti antifog in policarbonato

- Silicone swimming pool/sea goggles
- Wide field of vision
- Super comfortable
- Quick-adjust buckles
- Polycarbonate antifog lenses



YELLOW - LIGHT BLUE



LIGHT BLUE - CLEAR



▶ Suggested Pack: 12 pz

COLOR	COD.	EAN	€
RED - CLEAR	OCC121	8056138183810	
YELLOW - LIGHT BLUE	OCC122	8056138183827	
LIGHT BLUE - CLEAR	OCC120	8056138183803	

FRIPP



- Occhiale nuoto piscina/mare in silicone
- Ampio campo visivo
- Super confortevole
- Fibbie a regolazione rapida
- Lenti antifog in policarbonato

- Silicone swimming pool/sea goggles
- Wide field of vision
- Super comfortable
- Quick-adjust buckles
- Polycarbonate antifog lenses



LIGHT BLUE - WHITE



▶ Suggested Pack: 12 pz

COLOR	COD.	EAN	€
LIGHT BLUE - WHITE	OCC131	8056138183841	
RED - WHITE	OCC130	8056138183834	

RIVA Grey - Light Blue

ADULTsize



- Scarpetta multiuso per spiaggia, scogliera o qualsiasi superficie irregolare
- Realizzata in Neoprene bifoderato super elastico
- Suola antiscivolo rinforzata
- Rapida calzata, ultra confortevole
- Assicura un ottimo appoggio, maggior grip e protezione su superfici irregolari e su scogliere
- Adatta inoltre per camminare sulla sabbia nei periodi di massima temperatura

RIVA Orange - Light Blue

MIDsize



- Multipurpose shoe for beach, rocks and any uneven surface
- Made of extra stretchy double-lined neoprene
- Reinforced non-slip sole
- Quick, ultra-comfortable fit
- Provides excellent support, extra grip and protection on uneven surfaces and rocks
- Also suitable for walking on sand at peak temperatures

RIVA Light Blue - Purple

MIDsize



RIVA Grey - Light Blue

▶ Suggested Pack: 6 pz

SIZE	COLOR	COD.	EAN	€
41	Grigio/Azzurro	SNS0341	8056138183162	
42	Grigio/Azzurro	SNS0342	8056138183179	
43	Grigio/Azzurro	SNS0343	8056138183186	
44	Grigio/Azzurro	SNS0344	8056138183193	
45	Grigio/Azzurro	SNS0345	8056138183209	

RIVA Orange - Light Blue

▶ Suggested Pack: 6 pz

SIZE	COLOR	COD.	EAN	€
35	Arancio/Azzurro	SNS0135	8056138183049	
36	Arancio/Azzurro	SNS0136	8056138183056	
37	Arancio/Azzurro	SNS0137	8056138183063	
38	Arancio/Azzurro	SNS0138	8056138183070	
39	Arancio/Azzurro	SNS0139	8056138183087	
40	Arancio/Azzurro	SNS0140	8056138183094	

RIVA Light Blue - Purple

▶ Suggested Pack: 6 pz

SIZE	COLOR	COD.	EAN	€
35	Azzurro/Viola	SNS0235	8056138183148	
36	Azzurro/Viola	SNS0236	8056138183117	
37	Azzurro/Viola	SNS0237	8056138183124	
38	Azzurro/Viola	SNS0238	8056138183100	
39	Azzurro/Viola	SNS0239	8056138183131	
40	Azzurro/Viola	SNS0240	8056138183155	

DRY BAG BEACH



BLUE



WHITE



CARBON LOOK



YELLOW

ORANGE

CARBON LOOK

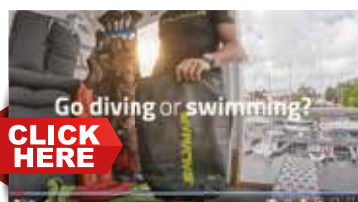

- Borsa stagna multifunzionale per qualsiasi attività outdoor che richiede una protezione totale degli oggetti inseriti
- Saldature stagne, materiale resistente al salino e alle abrasioni
- Sistema "Hands Free", Spallacci esterni regolabili con moschettone per il trasporto a spalle o tradizionale

- Multifunctional watertight bag for any outdoor activity that requires total protection of the objects it contains
- Watertight seams, salt and abrasion resistant material
- "Hands Free" system, adjustable external shoulder straps with snap hook for shoulder or traditional carrying

COLOR	CAPACITY	COD.	EAN	€
BLUE	5 lt.	BAG0105B	8056138182264	
WHITE	5 lt.	BAG0105W	8056138182257	
YELLOW	10 lt.	BAG0110Y	8056138182288	
ORANGE	10 lt.	BAG0110O	8056138182271	
CARBON LOOK	20 lt.	BAG0120C	8056138182295	
CARBON LOOK	10 lt.	BAG0110C	8056138184961	
CARBON LOOK	5 lt.	BAG0105C	8056138184954	

DRY SACK PHONE



BLUE

YELLOW

ORANGE

- Sacca Impermeabile, resistente alla sabbia, anti-neve, anti-polvere
- Schermo protettivo trasparente altamente sensibile al tatto

- Waterproof, sand-resistant, snowproof, dustproof bag
- Highly touch-sensitive, clear protective screen

COLOR	CAPACITY	COD.	EAN	€
BLUE	2,5 lt.	BAG0102B	8056138182325	
YELLOW	2,5 lt.	BAG0102Y	8056138182318	
ORANGE	2,5 lt.	BAG0102O	8056138182301	

Via G. Farina 2/4/6
16030 Casarza Ligure - Ge - Italy
info@salvimar.com
www.salvimar.com